



RADAR LEVEL METERS WITH GUIDED WAVE GRLM-70



CONTENTS

1. Basic description	4
2. Range of application	4
3. Variants of sensors	5
4. Dimensional drawings	6
5. Installation and putting into operation	8
6. Mechanical mounting.....	9
7. The installation of the custom measuring electrode,exchange or shortening of the electrode... 19	
8. Electrical connection.....	23
9. GRLM-70 connection examples	25
9.1. Connection diagram of the level meter with current output to the UHC-01 converter . 25	
9.2. Connection diagram of the level meter with the Modbus output to the URC-485 unit . 27	
9.3. Connection diagram of the level meter with the current output to the PCU unit	28
9.4. Connection diagram of the level meter with the current output to the PDU unit	29
9.5. Connection diagram of the level meter with the current output to the MGU unit	29
9.6. Connection diagram of the level meter with the MODBUS output to the MGU unit using RS485 / MODBUS	29
10. Setting elements.....	31
11. Settings	32
11.1. Initial setting procedure during commissioning	32
11.2. Basic settings	33
11.3. Service settings	36
11.4. Additional functions	39
12. HART® protocol	42
12.1. Parametrization of GRLM-70 using the Hart® protocol with PCU-100-H	43
12.2. Parametrization of GRLM-70 using the Hart® protocol with the UHC-01 communicator.....	43
13. Protocol Modbus®	44
14. Function and status indication	44
15. Order code	45
16. Accessories	46
17. Safety, protection, compatibility and explosion proof	46
18. Use, manipulation and maintenance	47
19. General conditions and warranty	47
20. Marking of labels	48
21. Technical specifications.....	50
22. Packing, shipping and storage	58
23. Menu structure.....	59

USED SYMBOLS

To ensure maximum safety of control processes, we have defined the following safety instructions and information. Each instruction is labelled with the appropriate pictogram.



Alert, warning, danger

This symbol informs you about particularly important instructions for installation and operation of equipment or dangerous situations that may occur during the installation and operation. Not observing these instructions may cause disturbance, damage or destruction of equipment or may cause injury.



Information

This symbol indicates particularly important characteristics of the device.



Note

This symbol indicates helpful additional information.

SAFETY



All operations described in this instruction manual have to be carried out by trained personnel or by an accredited person only. Warranty and post warranty service must be exclusively carried out by the manufacturer.

Improper use, installation or set-up of the sensor can lead to crashes in the application.

The manufacturer is not responsible for improper use, loss of work caused by either direct or indirect damage, and for expenses incurred at the time of installation or during the period of use of the level sensors.

1. BASIC DESCRIPTION

The **GRLM[®] radar level meters** are compact measuring devices consisting of three main parts - measuring electrodes, housing with the computing electronics (head) and a display module (screen). The electronic transmits very short electrical pulses (0.5 ns), which is connected with a one-wire transmission line (measuring electrode). Measuring electrode can be formed from rod or rope. The pulse propagates along the electrode in the form of electromagnetic wave toward the level part of electromagnetic wave, where it is partly reflected and the reflected returned to the receiving module of the electronic. The electronic measures the time of flight of electromagnetic wave and the current (actual) distance to the level is calculated. Then based on the height of the level, the level meter current output 4 ... 20 mA is set with the HART communications or an industrial RS-485 line with Modbus RTU communications and the measured value is shown on the display.

2. RANGE OF APPLICATION

Radar level meters with guided wave are suited to continuous level measurement of various liquid, mush and bulk-solid materials. Level meters are resistant against changes in the atmosphere (pressure, temperature, dust, steam) and to changes in medium parameters (change in dielectric constant, conductivity).

3. VARIANTS OF SENSORS

- **GRLM-70_-00** **Without electrode**, the electrode is made by customer (only variant 10 or 30) and connected to the electrode junction by M8 thread.
- **GRLM-70_-10** **Uncoated stainless steel rod electrode**, for level measurement liquids and bulk solid materials (water solutions, emulsion, oils, diesel, flour, sand, granulates, etc.). Electrode length 0,5 ... 8 m.
- **GRLM-70_-11** **Fully coated stainless steel rod electrode (PFA)**, for level measurement of aggressive liquids and very pure liquids. Electrode length 0,5 ... 2 m.
- **GRLM-70_-12** **Fully coated stainless steel rod electrode (FEP)**, for level measurement of aggressive liquids and drinks. Electrode length 0,5 ... 2 m.
- **GRLM-70_-13** **Semi-coated stainless steel rod electrode (FEP)**, for level measurement of liquids in area, where it could condense steam on the electrode. Electrode length 0,5 ... 8 m.
- **GRLM-70_-20** **Uncoated stainless steel rod electrode with reference tube (coaxial)**, for accurate level measurement of liquids in cramped spaces. Electrode length 0,5 ... 3 m.
- **GRLM-70_-30** **Uncoated stainless steel rope electrode and weight**, for level measurement of liquids and bulk solid materials (water, grains, sand, flour, cement, etc.) in higher silos, vessels, reservoirs. Electrode length 1 ... 40 m.
- **GRLM-70_-32** **Fully coated stainless steel rope electrode (FEP) and coated weight (PTFE)**, for level measurement of aggressive liquids and very pure liquids. Electrode length 1 ... 12 m.
- **GRLM-70_-33** **Uncoated stainless steel rope electrode with anchorage**, for level measurement of bulk solid materials (grains, flour, cement, etc.) It is recommended to anchor in storage tanks and silos for bulk solid materials up to a depth of 10 meters. . Electrode length 1 ... 40 m.
- **GRLM-70_-34** **Coated stainless steel rope electrode (Polyamide) and uncoated weight**, for level measurement of liquids and adhesive bulk solids (flour, cement, etc.). Electrode length 1 ... 40 m.
- **GRLM-70_-35** **Coated stainless steel rope electrode (Polyamide) with uncoated anchorage**, for level measurement of adhesive bulk solids (flour, cement, etc.). It is recommended to anchor in storage tanks and silos for bulk solid materials up to a depth of 10 meters. Electrode length 1 ... 40 m.
- **GRLM-70_-36** **Uncoated rope electrode without weight**, for level measurement of unsticky bulk solids (grains, sand, etc.) **Anchoring with rope clamps and eye ring**. Recommended anchoring in storage tanks and silos deeper than 10 meters. Electrode length 1 ... 40 m.
- **GRLM-70_-37** **Coated rope electrode without weight (rope coated with polyamide)**, for level measurement of sticky bulk solids (flour, cement, etc.). **Anchoring with cable clamps and eye ring**. Recommended anchoring in storage tanks and silos deeper than 10 meters. Electrode length 1 ... 40 m.

4. DIMENSIONAL DRAWINGS

GRLM-70_00

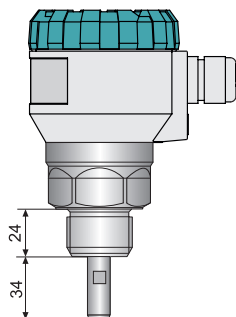

GRLM-70_10

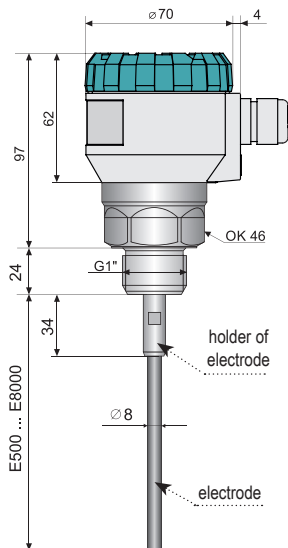

GRLM-70_11(12)

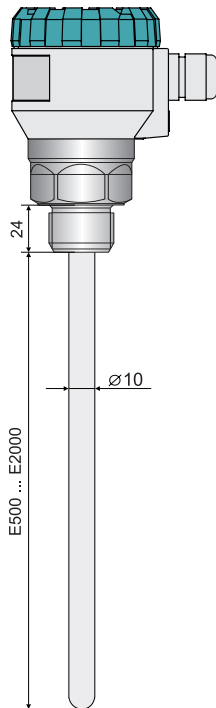

GRLM-70_13

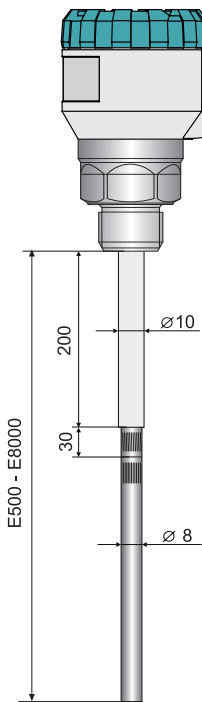

GRLM-70_20

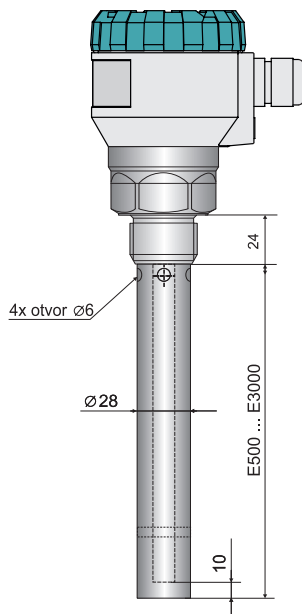

Procesní připojení
Tri-clamp

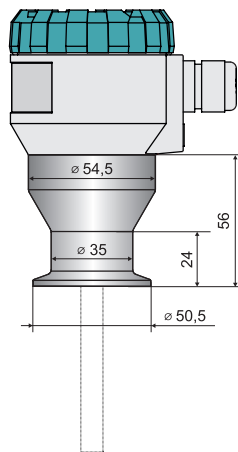

GRLM-70_-30(33,34,35)

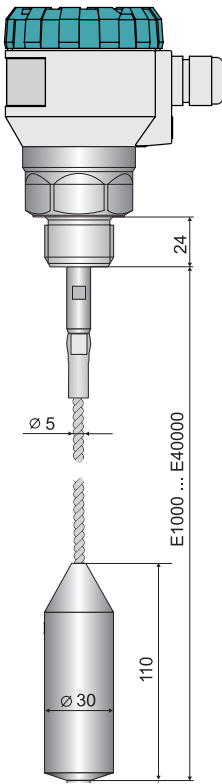

GRLM-70_-32

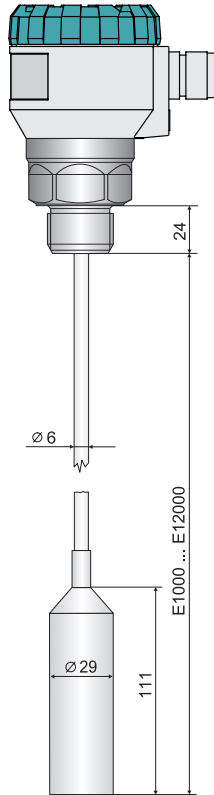

GRLM-70_-36(37)

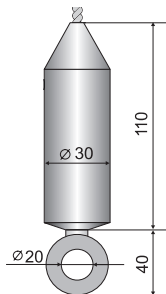
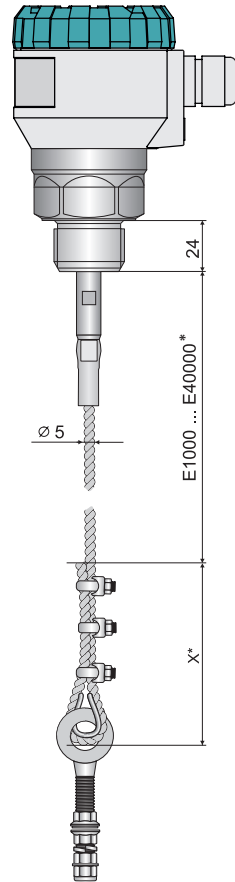

Anchoring eye for variant
GRLM-70_-33 (35)

* Details on rope length, attachment or shortening for version GRLM-70_-36 (37) on pages 22 and 37.

**High temperature performance
GRLM-70_T**

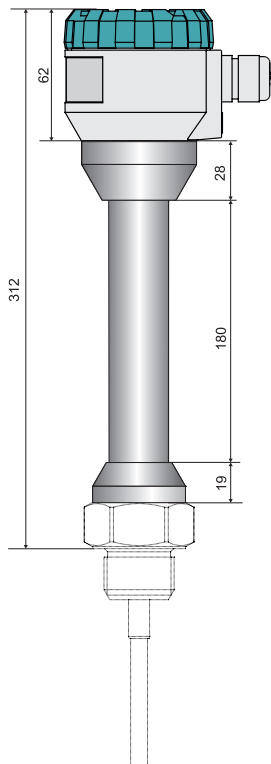

**performance "H1"
cable gland for protective hose M16**

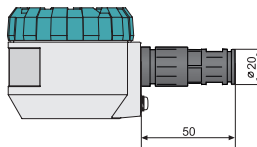

**performance "B1"
plastic cable gland M16**

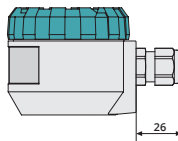

**performance "B2"
plastic cable gland M20**

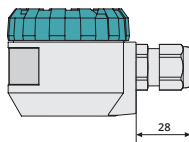

5. INSTALLATION AND PUTTING INTO OPERATION

Please follow next 4 steps:

- **MECHANICAL MOUNTING - SEE CHAPTER 6**
- **ELECTRICAL CONNECTION - SEE CHAPTER 8**
- **SETTINGS - SEE CHAPTER 11**

6. MECHANICAL MOUNTING

BASIC INFORMATIONS

VALID FOR: all types

- Install the level meter into the upper lid of the tank or reservoir using a welding flange or fastening nut.
- The min. distance to install the level meter into a lid or a ceiling of a tank from the tank wall or bottom is given in table below.
- Otherwise, the level meter install as far as possible from the walls, to the middle between the wall and the vertical inlet, see Fig. 1., 2, 3 and 4.

DISTANCE TO TANK WALL

type of wall	d (without ref. tube)	d (with ref. tube)
metal	≥ 300 mm*	any distance
non-metal	≥ 500 mm*	any distance

* it is recommended that a smaller distance from a wall is consulted with the manufacturer.

DISTANCE TO BOTTOM

type of electrode	h
rod (no anchoring)	≥ 100 mm ²⁾ (length of electrode to 2 m) ≥ 150 mm ²⁾ (length of electrode over 2 m)
rope (no anchoring)	≥ 100 mm (length of electrode to 10 000 mm) ≥ 150 mm (length of electrode over 10 000 mm)

²⁾ In case of a sloping bottom the distance "h" should be twice as long.

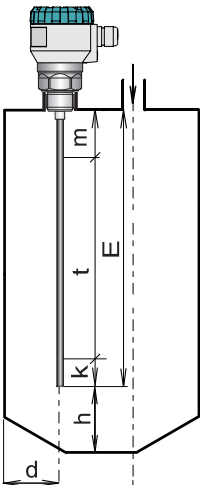

Fig. 1: Level meter installation with the rod electrode

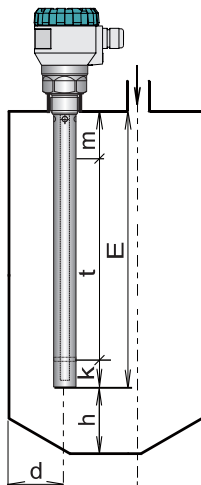

Fig. 2: Level meter installation with the reference tube

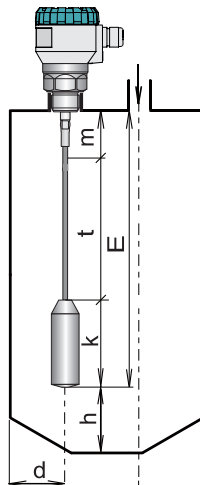

Fig. 3: Level meter installation with the rope electrode

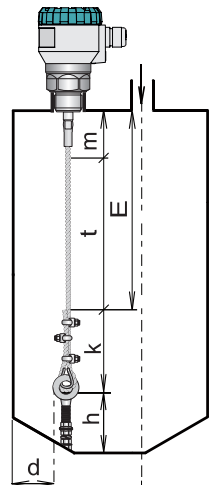

Fig. 4: Level meter installation with the rope electrode without weight

- E – The length electrode
- t – Maximum measuring range
- m – Dead zone on the beginning of electrode
- k – Dead zone on the end of electrode or the length of weight (110 mm) at the rope
- d – The distance from the tank wall (see. Tab. above)
- h – The distance from the bottom (see. Tab. above)

MEASURING RANGE

VALID FOR: all types

- It is an area in which continuous level measurement takes place. The maximum measuring range is determined by the length of the measuring electrode with the subtraction of dead zones at the beginning and at the end of the electrode, see Figs. 1, 2, 3, and 4. This range is also the default setting of the level meter. The maximum measuring range can be reduced by the user by changing the minimum and maximum levels in case of obstacles near the end or in particular at the beginning of the measuring electrode.
- If the measured level falls out of the measuring range limits, the level meter will enter the failure mode and the output current will resume the value that was set by the user, see service settings – Failure Mode, p. 38 (the default value for the failure mode is provided in the Default Settings Table, p. 57). For the M Modbus version, the corresponding bits of the measurement status register 104 are activated, see the Variables Table for GRLM-70 Modbus.

DEAD ZONE

VALID FOR: all types

- In connection with the measurement principle, electromagnetic waves reflected in the area immediately below the level meter and also at the end of the electrode cannot be evaluated (see Figs. 1, 2, 3, and 4). These zones determine either the minimum possible distance between the level meter and the highest level (“m” parameter) or the minimum distance at the end of the electrode (“k” parameter). **The level meter must be installed in such a way that the level does not interfere with the dead zones at the maximum and minimum possible filling of the storage tank.**
- The size of the dead zone is shown in Figs. 49–52 on pages 51, 52.

INPUT NECK

VALID FOR: all types except GRLM-70_-20

- For correct measurement, it is important to avoid installing the level meter in a high input neck or high welding flange. If this is not possible, the level meter may be installed in a **short input neck**, the parameters of which are provided in fig. 5. Here it applies that the neck diameter selected should be as large as possible but the neck height should be as small as possible.

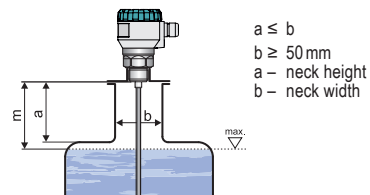

Fig. 5: Level meter installation in the input neck



When installing the level meter into an input neck, use the TEACHING procedure (see chapter 11.2. Basic settings). This will put the sensor into a mode that suppresses false reflections.

- The end of the socket or the welding flange must not have an extension into the tank in Fig. 6.
- Dimension restrictions of the input nozzle does not apply to the use of GRLM-70_-20 with reference tube.

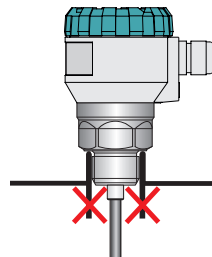

Fig. 6: Incorrect welding flange mounting to the tank

NON-METAL TANK

VALID FOR: all types except GRLM-70_-20

- To install the level meter in a non-metallic water tank, it is necessary to insert a metal plate with a diameter greater than 200 mm in the area of the process connection, see fig. 7. The metal plate must be in contact with the thread stop of the level meter.

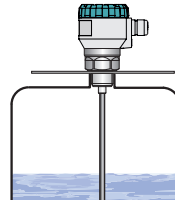

Fig. 7: Level meter installation in the non-metal tank

CONCRETE SILO

VALID FOR: GRLM-70_-30, 32, 33, 34, 35, 36, 37

- When installing the level meter into the roof of a concrete silo, the level meter installation hole must be larger than the thickness of the concrete a , see fig. 8.
- In the event that the thickness of the concrete is greater than the diameter of the hole, it is necessary to install the level meter into a countersink, see fig. 9.

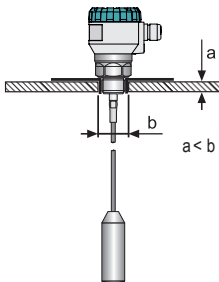

Fig. 8: Level meter installation on the roof of the concrete silo

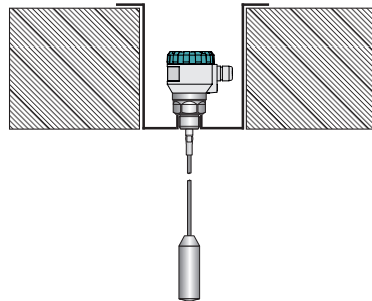

Fig. 9: Level meter installation on the roof of the concrete silo

LEVEL METER PROTECTION

VALID FOR: all types

- The level meter must not be installed in locations exposed to direct solar radiation and must be protected against the effects of weather. In the event that installation in a location with direct solar radiation is unavoidable, it is necessary to install a shielding cover above the level meter (fig. 10).

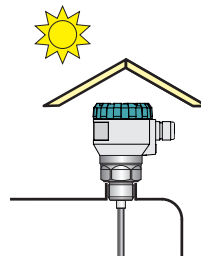

Fig. 10: Solar radiation shielding cover

- It is not recommend to install the level meter in or above the filling location. Measurement may be affected by the medium flowing in rather than measuring the level of the material.

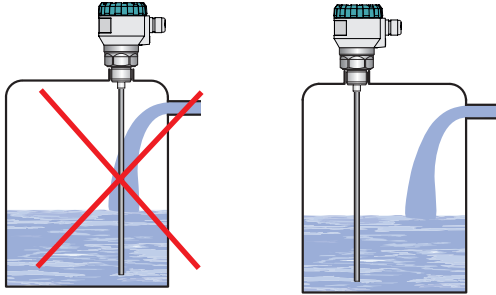

Fig. 11: Level meter installation outside the influence of filling

OBSTACLES IN THE TANK

- The level meter generates electromagnetic guided wave, which creates an electromagnetic field along the electrode. Objects placed close to the electrode disturb the electromagnetic field and thus affect the measurement. Therefore, it is determined protective zone along the electrode of radius 300 mm. The level meter is recommended to install the tank so that the items placed inside the tank (ladders, various partitions, mixers, etc.) does not intervene into the protective zone, see Fig. 12.

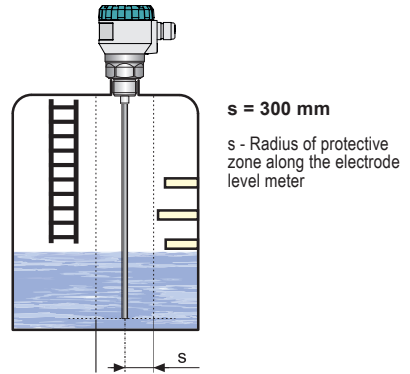

Fig. 12: Level meter installation outside obstacles in the tank

- If still these objects intervene into the protective zone of the level meter, it is necessary to create a map of false reflections by activating the "TEACHING" mode (p. 35). In case of installed mixers, it is necessary to position the mixers near the level meter (turning the mixer blade to the proximity of the electrode). Items inside the tank must not be from the electrode distance of less than 100 mm, because a interference of electromagnetic field is very strong in this zone and "TEACHING" mode can not be used.

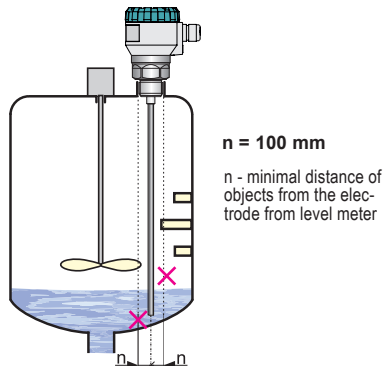

Fig. 13: Incorrect level meter installation close to obstacles

AGGRESSIVE MEDIA

- When measuring the level of aggressive media (strong acids, lyes, chlorides, hydrogen chloride, etc.) in non-conductive vessels.
- The level meter with a rod electrode is inserted into a non-conductive tube with a diameter of 16 ... 30 mm. The tube must have an encapsulated bottom and the upper part is welded to the non-conductive ceiling of the vessel.
- The level of the medium is measured through the wall of the non-conductive tube by a radar. The value of relative permittivity must not exceed 3.
- The instructions for mounting the level meter into a non-metallic vessel apply here, i.e. a metal plate with the diameter greater than 200 mm must be inserted at the process connection point.

VALID FOR: GRLM-70_-10

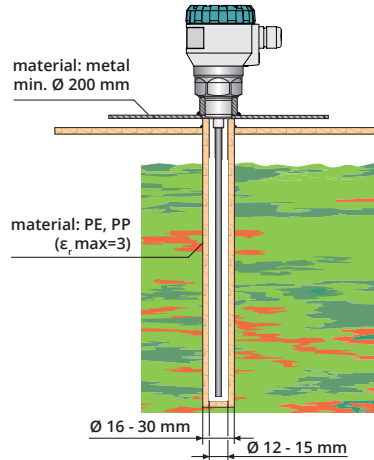

Fig. 14: Level meter installation with reference tube (coaxial) into the auxiliary tube

CRAMPED SPACES

- For the type of level meter with reference tube (coaxial) electromagnetic guided wave propagates inside the reference tube. This wave is not affected by the ambient environment. So for this type of radar is not intended protective zone around the electrodes and the level meter can be used for measurements in cramped spaces.

VALID FOR: GRLM-70_-20

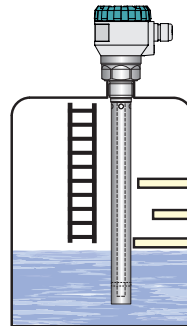

Fig. 15: Level meter installation with reference tube (coaxial) in cramped spaces

HUMIDITY

VALID FOR: all types

- It is appropriate to lead the cable underneath the cable terminal (through the dip diagonally downwards) This will prevent potential "ingression of moisture through the cable grommet. Thereby, rain and condensing water can flow away freely, fig. 16.
- The cable bushing and connector have to be sufficiently tightened to prevent penetration of humidity.

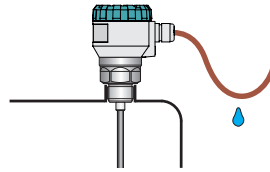

Fig. 16: Prevention to avoid intrusion of humidity through cable gland

DEPOSITS ON THE ELECTRODE

VALID FOR: all types

- Deposits, layers and sediments on the electrode may distort measurement and reduce the permeability of the electromagnetic wave propagated along the electrode.

VARIANT WITHOUT ELECTRODE

VALID FOR: GRLM-70_-00

- Type of level meter without electrode is supplied without an electrode. It is therefore necessary to a customer to mount his own made measuring electrode. The diameter of the electrode must be between 8-10 mm. For a connection it is necessary that on the electrode is made M8 thread. The connection procedure is given in Sec. 12 page. 30.

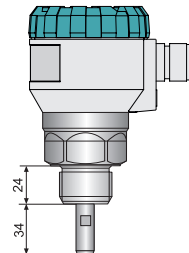

Fig. 17: Level meter without electrode



For the type of level GRLM-70_-00 manufacturer is not responsible for failures related to the mounted measuring electrode.

- When calculating the length of the rope electrode, it is necessary to take into account that the measurement takes place only up to the upper edge of the weight, i.e. it is advisable to choose the electrode length so that the whole weight is below the minimum measured level, see Fig. 18. **For variants 30 and 34, it is possible to shorten the rope electrode.**
- The distance the electrode from the tank wall must be at least 300 mm. Otherwise, the level meter install as far as possible from the walls, to the middle between the wall and the vertical inlet, see Fig. 18. It must be ensured that the rope electrode could not touch the vessel wall caused by the motion of the medium. In the case of an unanchored rope electrode, its end must not extend into the conical part of the storage tank.
- Ensure that the maximum tensile load on the rope of the electrode is not exceeded. Its value is specified in chapter "Technical parameters". A large load could result in the rope tearing. The tensile load depends on the height and shape of the tank, the thickness and adhesion of the measured medium and the tank emptying speed.

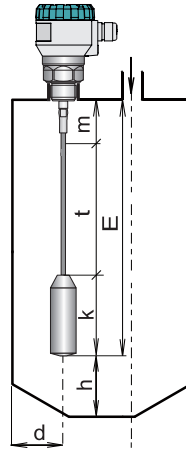

Fig. 18: Level meter installation with the rope electrode

$$E = m + t + z$$

- E – The length of rope electrode
- t – Measuring range
- m – Dead zone at the beginning of the electrode
- k – The length of weight (110 mm)
- d – The distance from the tank wall min. 300 mm
- h – The distance from the bottom (see. Tab. page 8)



For the electrode shortening procedure, see chapter 7. How to install a custom measuring electrode, replace or shorten the electrode.



In the case of shortening the electrode, after installation it is necessary to carry out settings in the MENU of the ELECTRODE option (see p. 36).

ANCHORING OF THE ROPE ELECTRODE WITH WEIGHT AND ANCHORING RING

VALID FOR: GRLM-70_-33, 35

- At the bottom of the tank (silo), it is necessary to install an anchoring point (by welding or drilling an anchoring ring), to connect to the ring at the end of the electrode.
- This anchoring is recommended **for applications with liquids**, where turbulences occur or media is stirred, or for applications with bulk solids in small and medium sized silos (up to 10 m height).



For the electrode shortening procedure, see chapter 7. How to install a custom measuring electrode, replace or shorten the electrode.



In the case of shortening the electrode, after installation it is necessary to carry out settings in the MENU of the ELECTRODE option (see p. 36).

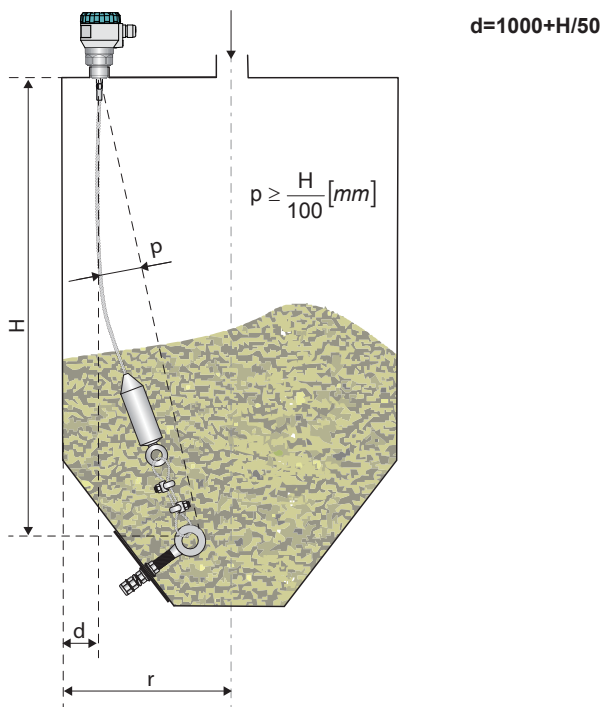

Obr. 19: Recommended Level meter installation with anchorage

ANCHORING OF THE ROPE ELECTRODE WITHOUT WEIGHT, ANCHORED WITH CLAMPS

VALID FOR: GRLM-70_-36, 37

- For the variants 36 and 37, an additional 1 m of stainless steel rope length is supplied with a corresponding number of clamps and eye rings.
- This additional 1 m of stainless steel rope is intended as a reserve for pulling through the anchoring eye. **Not intended for level measurement!** It comes with three clamps and one eye ring.
- At the bottom of the tank (silo), it is necessary to install an anchoring point (by welding or drilling an anchoring ring), to pull the rope through and then attached with at least 2 clamps (3 clamps are recommended for deep silos over 20 m). When designing the length of the rope "E", it is necessary to take into account the bending of the rope, or anchoring on the opposite side of the silo.
- **Suitable for bulk media in silos deeper than 10 meters.**
- **For applications with bulk solids** it is appropriate to anchor the rope electrodes at the opposite sides of the tank (silo) so that the rope is sagging, see Fig.20. Minimum recommended sag is $p = H/100$ [mm]. This installation increases the resistance of the rope to tension load.

ANCHORING METHODS DEPENDING ON THE SIZE OF THE SILO

Anchoring method	r [mm]
opposite side of the silo (Fig. 20)	any
same side of silo (Fig. 21)	$\geq 1000 + H/20$

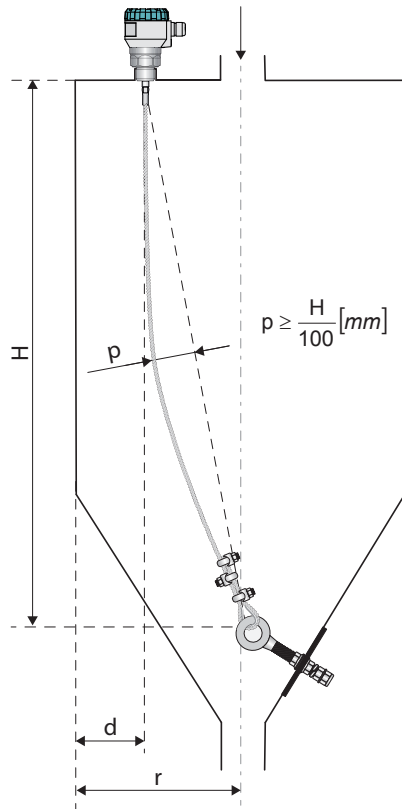

Fig. 20: Recommended installation of the level meter with anchoring on the opposite side of the silo

- H – depth of the silo (from rope start to anchor)
- p – rope sag (see formula above)
- r – radius of the silo
- d – distance to wall (see formula above)

- If the ratio of silo width to depth is determined by formula: $r \geq 1000 + H/20$ [mm], the rope can be anchored also on the same side of the silo, see Fig.21.

⚠ After installing the rope using clamps, a check of the min. distance of the rope from the wall (d) and also the bend of the rope (p) is performed. Then the rest of the rope must be cut in close proximity to the last clamp, see chapter 7.

i After installation, it is necessary to carry out settings in the MENU of the ELECTRODE option (see p. 36).

i A mounting kit for rope anchoring and a rope tensioner are available as accessories.

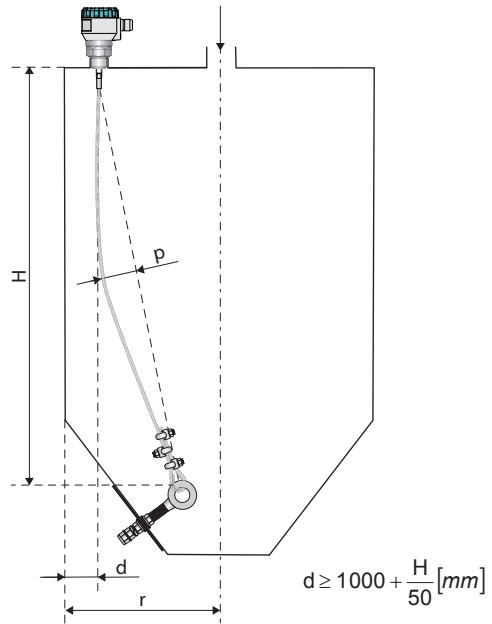

Fig. 21: Recommended installation of the level meter with anchoring on the same side of the silo

ANCHORING OF THE ROD ELECTRODE **VALID FOR: GRLM-70_-10, 11, 12, 13**

- Recommended for rod electrodes longer than 3 m.
- The end of the measuring electrode may be installed in a short tube welded to the bottom of the tank. At the bottom part of the anchoring tube, it is recommended to have a media overflow hole. The diameter of the tube should ensure permanent contact of the tube walls with the electrode.

ELECTRODE WIDTH	
electrode type	d
uncoated	8 mm
fully coated	10 mm

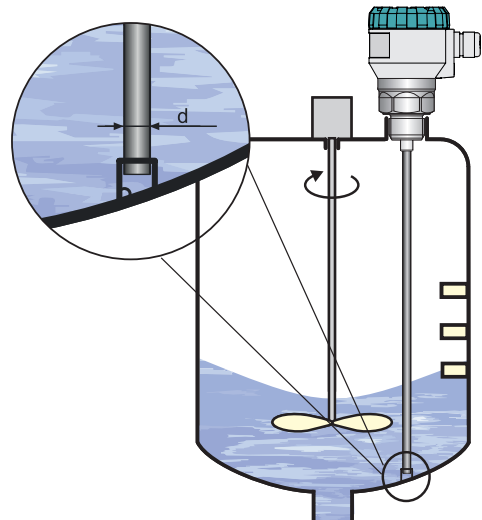

Fig. 22: Recommended installation of the level meter with anchoring of the rod electrode

7. THE INSTALLATION OF THE CUSTOM MEASURING ELECTRODE, EXCHANGE OR SHORTENING OF THE ELECTRODE

The installation of the custom measuring electrode, - applies to type 00

1. Create your own electrode as shown on Fig. 23 or 24. The length of the electrode must be about 7 mm shorter than the dimension "E" in figure 23. The material of the electrode is recommended to be used stainless steel type 1.4404 (AISI 316 L) or similar depending on the application.
2. Apply glue intended for securing threaded junctions (the amount of adhesive is determined by its manufacturer) on to the thread of the prepared electrode produced according to drawing (see pic. 23 or 24). The glue used must meet certain criteria depending on the application, e.g. resistance against high temperatures, corrosion, chemicals or must have a permit, e.g. for use in food processing.
3. Screw the electrode using suitable pliers or a spanner (on the side of the electrode) and a flat spanner 10 mm (on the side of the electrode holder) firmly into the electrode holder.
4. Let the glued junction to harden, as recommended by the glue manufacturer, then the level meter is ready for installation.
5. After an installation into an empty tank, set a new level meter electrode type and the length - see Chap. ELECTRODE on the page 36
6. If necessary, enter a new range of level measurement - see Chap. MIN / MAX LEVEL on the page 33.

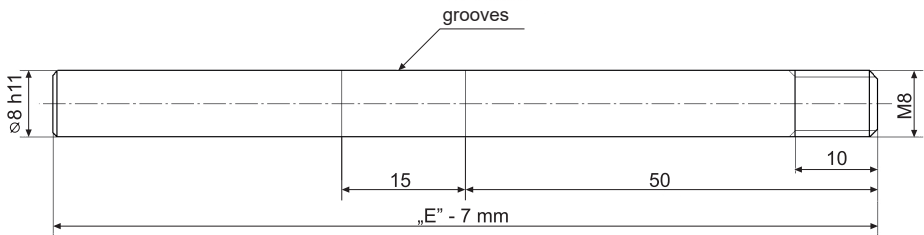

Fig. 23: Detail of a drawing of a rod electrode

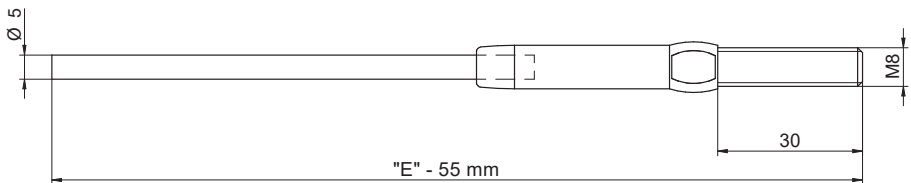

Fig. 24: Detail of a drawing of a rope electrode

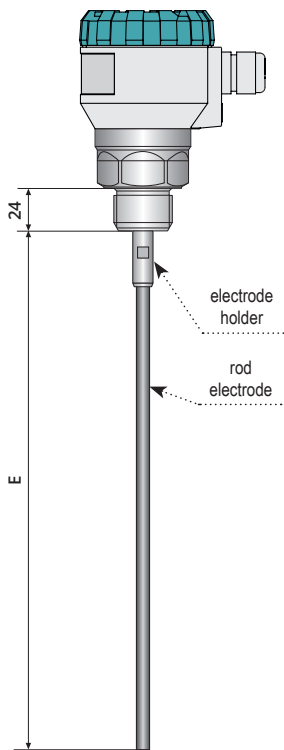

Fig. 25: Drawing of a level meter with a rod electrode

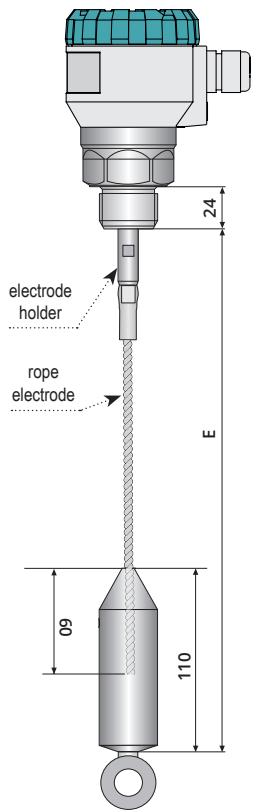

Fig. 26: Drawing of a level meter with a rope electrode

How to replace the measuring electrode

– applies only to variants 10, 30, 33, 34, 35, 36, and 37

1. Heat the junction place (threaded connection) of the electrode and the electrode holder (see Fig. 27 and 28) using a heat gun at about 120-150 ° C (or 220-250 ° C for high temperature version).
2. Unscrew the electrode using suitable pliers (for rod electrodes) or flat spanner 7 mm (in case of rope electrode) and a flat spanner 10 mm (on the side of the electrode holder) away from the electrode holder.
3. Apply the glue for securing of threaded fasteners (glue quantity specified by the manufacturer) to the thread of the new electrode. The used glue must meet the requirements depend on the specific application, for example: withstanding high temperatures, corrosive chemicals, resp. contact with food.
4. Screw the electrode using suitable pliers or a spanner (on the side of the electrode) and a flat spanner 10 mm (on the side of the electrode holder) firmly into the electrode holder.
5. Let the glued junction to harden, as recommended by the glue manufacturer, then the level meter is ready for installation.
6. After an installation into an empty tank, set a new level meter electrode type and the length - see Chap. 11.3. ELECTRODE
7. If necessary, enter a new range of level measurement - see Chap. 11.2. MIN / MAX LEVEL.

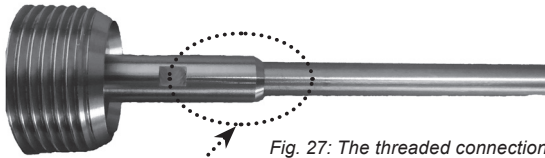

Fig. 27: The threaded connection of the electrode holder with the rod electrode

Places to be heated, see "The procedure of replacement of the measuring electrode....."

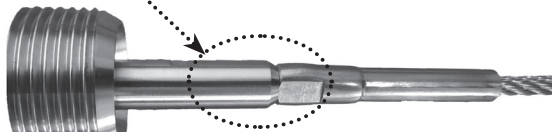

Fig. 28: The threaded connection of the electrode holder with the rope electrode

Shortening of the measuring electrode
- only to versions 10, 13, 30, 33, 34, 35

1. If necessary, remove the rod or rope electrode from the electrode holder - see points 1 and 2 of "The procedure of replacement of the measuring electrode"
2. Shorten the rod electrode by means of a suitable metal saw and file the end of the electrode. The length of this electrode must be 7 mm shorter than dimension "E" in pic. 31. At the rope electrode, it is necessary to loosen three fastening screws on the ballast and to pull out the end of the cable, see fig. 23. Make sure that the cable length is correct after shortening – the cable is suspended in the ballast up to a distance of approximately 60 mm. Ideally, shorten the cable using diagonal cutting pliers. Be careful to prevent the end of the cable from fraying.
3. In the case of a cable coated with polyamide (types 34 and 35), this insulation must be removed at the end of the cable to a distance of 60 mm so that the end of the cable can be inserted back into the ballast.
4. Insert the end of the cable back into the ballast and secure it in place by tightening all three screws.
5. If you unmounted the electrode from the electrode holder, re-assemble them - see paragraphs 3 to 7 of "The procedure of replacement of the measuring electrode"
6. Measure the length(s) of the cut rope. This length is used for the calculation, see the setting in the MENU of the ELECTRODE option (p. 36).

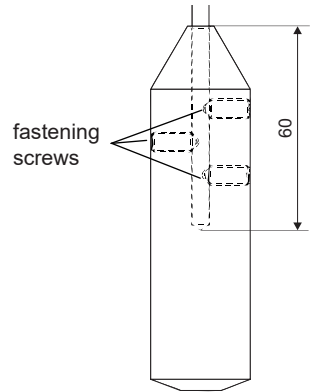

Fig. 29: Scheme of the weight for the rope electrode

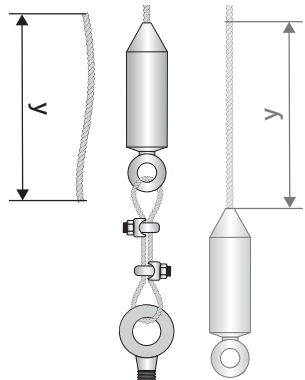

Fig. 30a: Drawing of the end of the rope for type 33, 35

How to shorten the measuring electrode
– applies only to variants 36, 37

1. For the types 36 and 37, the rope is pulled through the anchoring eye and anchored by means of clamps, see the Fig. The eye ring is used to increase the life of the rope at the point of contact with the eye. After tightening the clamps near the anchoring eye, the remaining end of the rope is removed.
2. Measure the length(s) of the cut rope. This length is used for the calculation, see the setting in the MENU of the ELECTRODE option (p. 36).

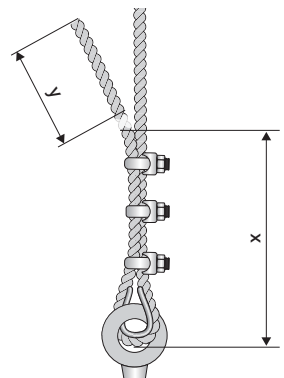

Fig. 30b: Drawing of the end of the rope for type 36, 37

8. ELECTRICAL CONNECTION

When using the M16 gland, the level meter is connected to the follow-up (evaluation) device using a suitable cable with the outer diameter of 6–8 mm by means of screw terminals located under the display module. The recommended cross section of cores for the current version $2 \times 0,5 \pm 0,75 \text{ mm}^2$ and for the version with Modbus communication $2 \times 2 \times 0,25 \text{ mm}^2$ (twisted pair, shielded). In the case of the Modbus version and where it is assumed that the device will not be at the end of the chain, we recommend using the M20 gland, which is suitable for 2 cables with the \varnothing of 5.5–7.5 mm. Plus pole (+U) is connected to the terminal (+), minus pole (0V) to the terminal (-) and the shielding (only for shielded cables) to the terminal (\perp). Communication wires A and B of the line RS-485 (for version "M" - Modbus) are connected to the terminals A and B.

Procedure to connect the cable to the level meter:

1. Unscrew the nut of the upper transparent lid.
2. Take the upper edge of the display module and take it out carefully by mild swinging up.
3. If you cannot grasp the module, you can use a small screwdriver. Insert it as far as the seam and use from several sides to slightly lift the module.
4. Release the cable outlet and thread the stripped supply cable in.
5. Connect the cable to the screw terminals according to the diagram in Fig. 32 or 34. Firmly tighten the terminals and the cable outlet. Tightening torque see. Technical parameters p. 36.
6. If the level meter with Modbus is involved as a terminal for RS-485, we recommend (to avoid reflections on the line) to connect 120 Ω termination resistor. This is done by moving a small lever of the switch marked 120 Ω to the ON position. On the level meters connected to the line RS-485 as an intermediate device, the termination resistors are not connected (switch remains off) in Fig 32.
7. Insert the display module back into the head so that the connector is properly connected.
8. Slide silicone seal on the thread of the level meter body, then tighten the nut of the upper lid. Connect the cable to consequential device.

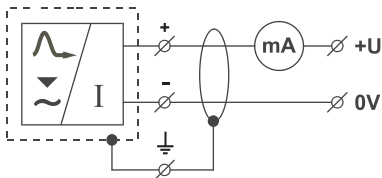

Fig. 31: Wiring diagram of the level meter with current output GRLM-70 _ _ _ - I

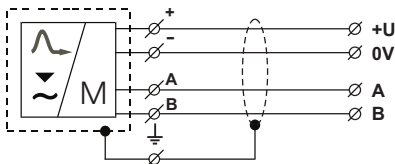

Fig. 33: Wiring diagram of the level meter with Modbus GRLM-70 _ _ _ - M

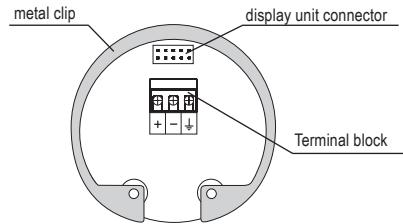

Fig. 32: Inside view of screw terminals of the level meter with current output GRLM-70 _ _ _ - I

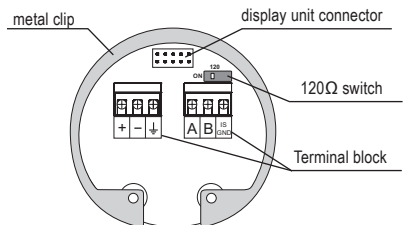

Fig. 34: Inside view of screw terminals of the level meter with Modbus GRLM-70 _ _ _ - M

Data connection RS-485 / MODBUS:

Maximum distance of the module from the continuous line (length of T segment) is 3 m (fig. 35).

At the end units, it is necessary to connect terminating resistors R_z 120 Ω , whilst the terminating resistors must not be connected on the continuous units (fig. 35).

The cable must be a shielded twisted pair with a core cross-section of 0.35 .. 0.8 mm² with an impedance of approximately 120 Ω .

The cable shielding is connected to a shielding clamp on the connector of line RS485 and is connected with the clamp of the PE switchboard (direct grounding) only at a single point.

In the event that the RS-485 line is lead outside of one lighting arrester, it is necessary to protect it via suitable overvoltage protection.

In the event of communication problems caused by strong interference, it is appropriate to install the system inside a metal switchboard and to install the strong interference sources (e.g. frequency converters) away from this switchboard.

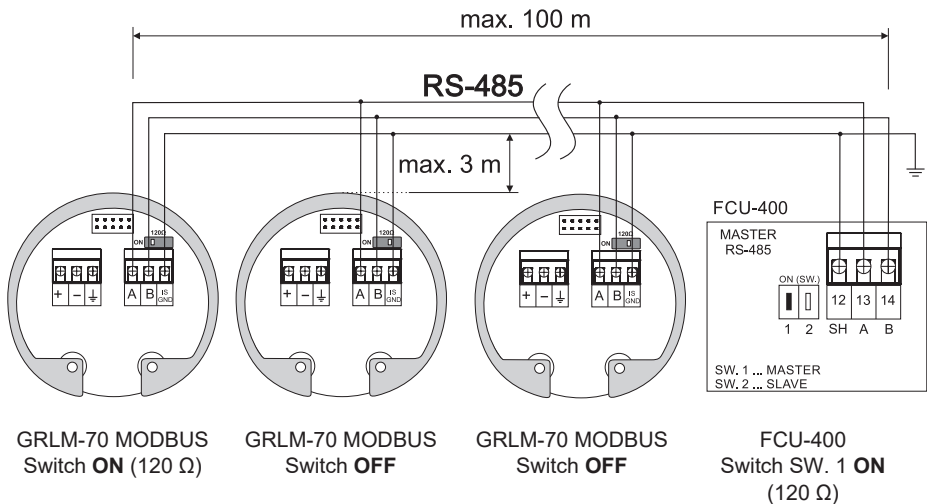

Fig. 35: Connection of multiple units via RS485 to a network



In the case of using the level meter version with gland B3 (D3), it is possible to use the RS-485 / Modbus chain connection, see chap. 9.6, Fig. 44.



Electrical connection can only be made when de-energized!

It is not possible to remove the electronics while filling the storage tank!

The source of the power voltage must comprise of a stabilised safe low power source with galvanic separation. In the event that a switch-mode power supply is used, it is essential that its construction effectively suppresses common mode interference on the secondary side. In the event that the switch-mode power supply is equipped with a PE safety terminal, it must be unconditionally grounded! Spark-safe devices type GRLM-70Xi(XiT) must be powered from a spark-safe power source meeting the above-mentioned requirements.

Due to the possible occurrence of an electrostatic charge on the non-conductive parts of the sensor, it is necessary to ground all sensors intended for use in environments with an explosion hazard GRLM-70Xi(XiT) and GRLM-70Xt(XtT). This can be performed by grounding el. conductive tanks or el. conductive tank lids, and in the case of el. non-conductive tanks using and grounding an auxiliary plate electrode PDE-27.

In the event that the sensor is installed in an outdoor environment at a distance greater than 20 m from the outdoor switchboard, or from an enclosed building, it is necessary to supplement the electrical cable leading to the sensor with suitable overvoltage protection.

In the event of strong ambient electromagnetic interference, paralleling of conductors with power distribution, or for distribution to distances over 30 m, we recommend grounding the level meter (see above) and using a shielded cable. Ground the shielding of the cable on the side of the power supply, or the shielding is possible to connect only on inside pin of the level meter marked \ominus see fig. 32 and 34 (the shielding of the cable is always connected in a single location).

9. GRLM-70 CONNECTION EXAMPLES

9.1. Connection diagram of the level meter with current output to the UHC-01 converter

The parametrization itself is performed using the UniScada Dinel software which is installed on the PC. The connection of the UHC-01 converter to the PC is typically made by a standard USB-A <-> USB-B cable.

The following four subchapters list all possible connection variants. All figures show the output side of the converter towards the level meter, including communication LED diodes and a switch for switching on/off the communication HART resistor.

Connection of the level meter powered by an internal source when using the internal HART communication resistor 250 Ω

This connection is used in case of connection of one level meter where no power supply is available or is not required and at the same time there is no communication HART resistor in the current loop. The switch is set to the ON position (highlighted in green).

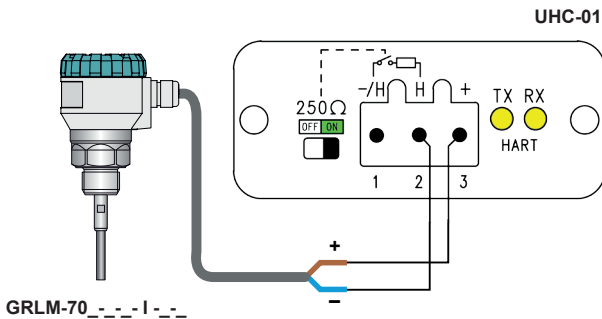

Fig. 36: Connection of a level meter powered by an internal source when using an internal communication HART resistor 250 Ω

Connection of a level meter powered by an internal source when using the external HART communication resistor 250 Ω

This connection is used in the case of connecting one level meter where no power supply is available or is not required and at the same time there is a communication HART resistor in the current loop. The switch is set to the OFF position (highlighted in green).

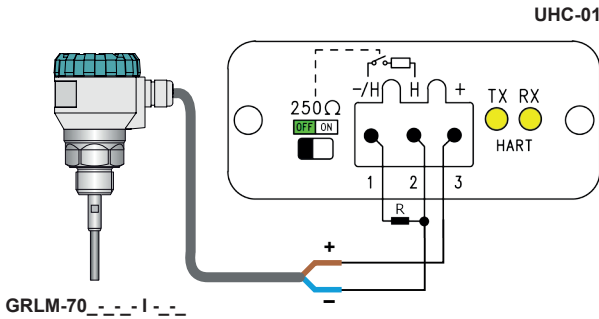

Fig. 37: Connection of a level meter powered by an internal source when using the external communication HART resistor 250 Ω

Connection of a level meter powered by an external source when using an internal communication HART resistor 250 Ω

This wiring is used in the case of connecting one level meter where the use of an external power supply is required and at the same time there is no communication HART resistor in the current loop. The switch is set to the ON position (highlighted in green). The external power supply is marked as U in the wiring.

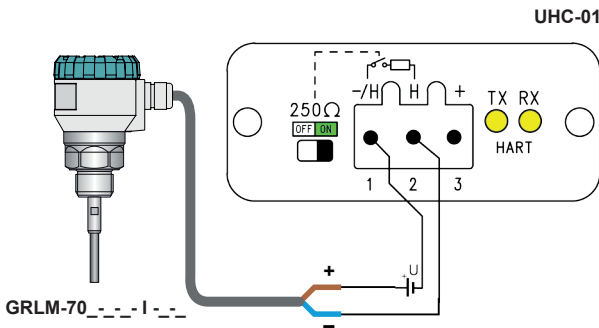

Fig. 38: Connection of a level meter powered by an external source when using an internal communication HART resistor 250 Ω

Connection of a level meter powered by an external source when using an external communication HART resistor 250 Ω

The said connection is used in case of connection of one level meter where the use of an external power supply is required and at the same time there is already a communication HART resistor in the current loop. The switch is set to the OFF position (highlighted in green). The external communication resistor is marked as R in the circuit and the power supply as U.

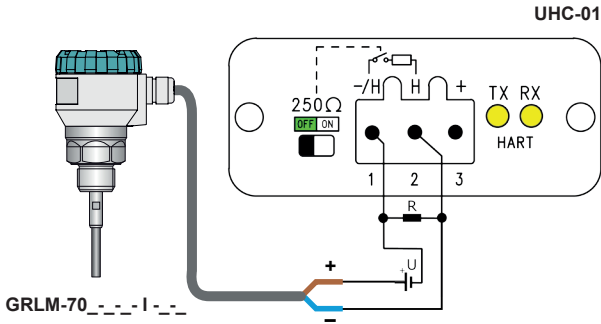

Fig. 39: Connection of a level meter powered by an external source when using an external communication HART resistor 250 Ω

9.2. Connection diagram of the level meter with the Modbus output to the URC-485 unit

Connection of a level meter powered by an external source to the URC-485 communication converter

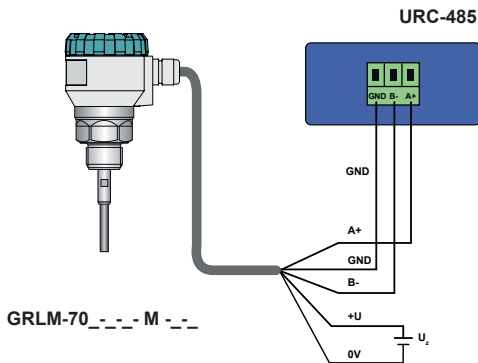

Fig. 40: Connection of a level meter powered by an external source to the URC-485 communication converter

9.3. Connection diagram of the level meter with the current output to the PCU unit

Demonstration in **MULTI-DROP** mode if HART® communication is in the **POINT-TO-POINT** mode, then only 1 level meter can be connected to the unit.

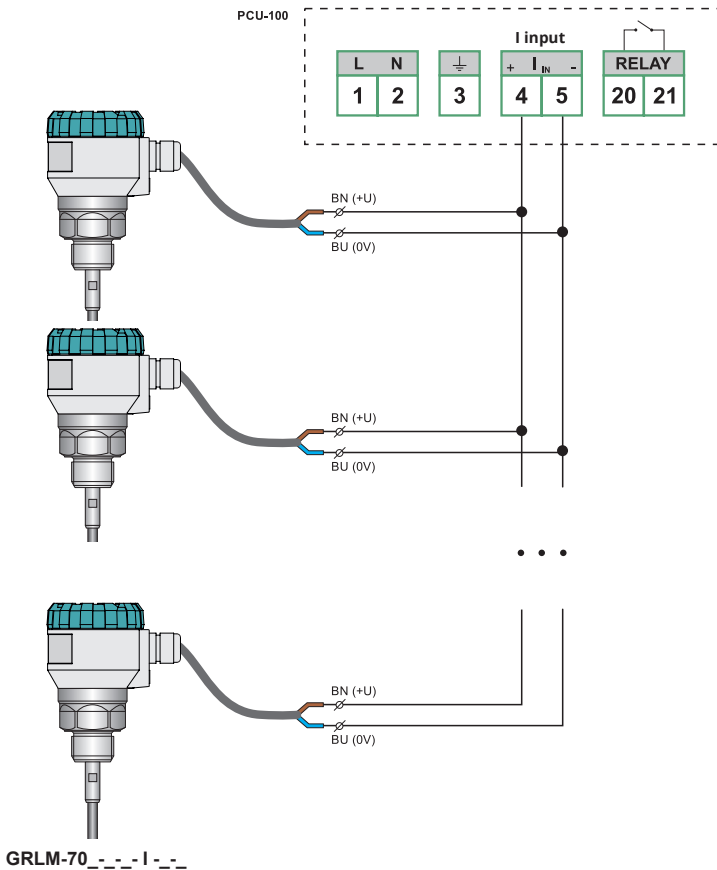

Fig. 41: Connection of a level meter with the current output to the PCU unit

9.4. Connection diagram of the level meter with the current output to the PDU unit

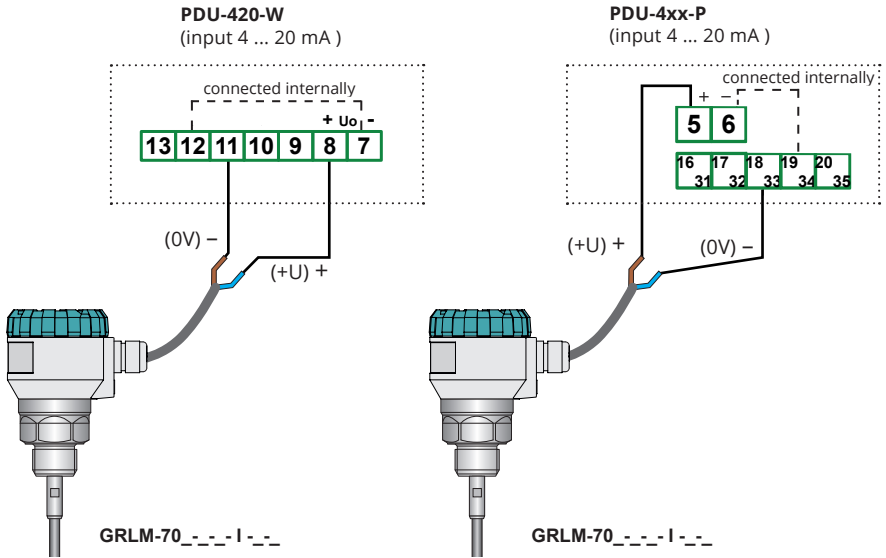

Fig. 42: Connection of a level meter with the current output to the PDU unit



The PDU-420-W connection diagram applies to firmware version 6.00 or higher. For older versions (up to the version 5.99), the level meter output + U is connected to terminal 7 and the 0 V output to terminal 10.

9.5. Connection diagram of the level meter with the current output to the MGU unit

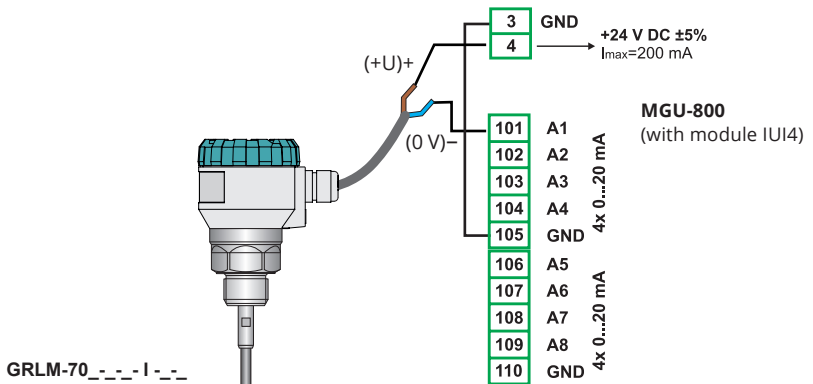

Fig. 43: Connection of a level meter with the current output to the MGU unit

9.6. Connection diagram of the level meter with the MODBUS output to the MGU unit using RS485 / MODBUS

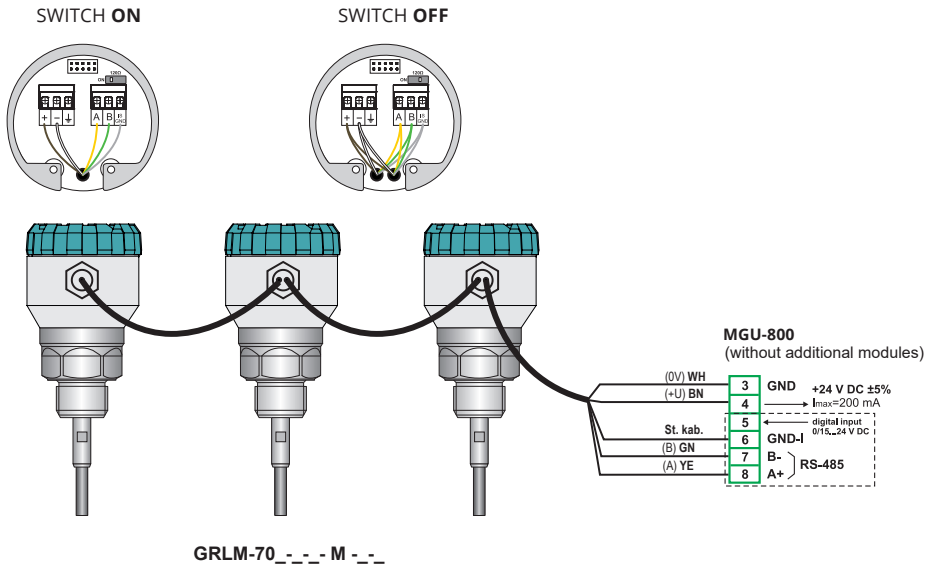

Fig. 44: Connection of the level meter with the MODBUS output to the MGU unit using RS485 / MODBUS



The level meters can be powered directly from the internal source (+24 V DC) of the MGU-800, but the maximum current consumption of 200 mA must not be exceeded.

10. SETTING ELEMENTS

Settings are performed using 3 buttons located on the display module DM-70. All the settings are available in the menu of the level meter.

button

- Set-up mode access
- Confirmation of selected item in the menu
- Move the cursor in the line
- Saving of set-up data

button

- Move in the menu
- Change of values

button

- Cancelling of carried out changes
- Shift one level up

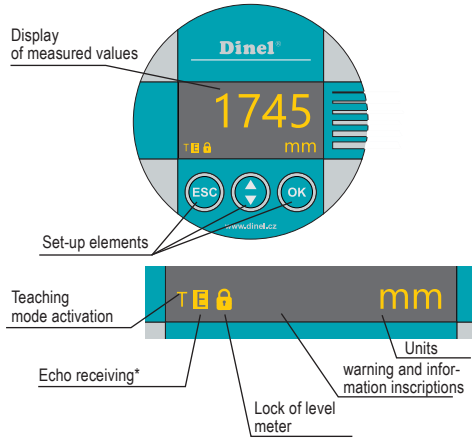

* Slow flashing while the reflected signal (echo) is received from the measured level.

• Status indication (left lower corner of the display):

symbol „E“ - **alternating flashing** - correct reception of the reflected wave indicating the level

symbol „T“ - **permanent shine** - "TEACHING" mode is activated

inverse shine - activation of the "TEACHING" mode

symbol  - **permanent shine** - the level meter is locked against unauthorized setting using a password, enter password to unlock (see MENU - PASSWORD)

• Warning inscriptions:

NO ECHO - when empty tank, after you perform the procedure TEACHING
- level meter is not able to measure (check the media or change the sensitivity)

FIXED OUTPUT - the output stream is fixed to a constant value (see DIAGNOSTIC - CURRENT)

LOW POWER - low supply voltage (must be in the range - see Technical specifications)

NO PASSWORD - the level meter is protected using a password against unauthorized setting

NO DATA AVAILABLE - display module doesn't communicate with the electronics of the level meter (e.g. incorrectly inserted display module into connector or measuring module is not functional).

• Information inscriptions:

DISTANCE TO LEVEL - the display shows the current distance
(see DIAGNOSTIC - DISTANCE)

CURRENT - the display shows the current proud (see DIAGNOSTIC - CURRENT)



Level meter GRLM-70_ _ _ _ _L is supplied without the display module (display) DM-70. To setup the level meter, it is necessary to connect a display module to it (or it can be configured via HART or MODBUS). When the settings are completed, the display module may be disconnected and the level meter then measures without it.

11. SETTINGS

The level meter is manually controlled using 3 buttons located on the removable display module DM-70 (see chapter Control elements, pg. 31).

The text "SAVED" at the bottom of the display indicates that the values have been saved. Values not confirmed by pressing button **OK** will **not be saved!** After 5 minutes of inactivity, the level meter automatically switches back to the measuring mode. If the password is activated, the level meter will also lock itself. Once it is locked, it is not possible to make **any** changes to the settings. When any editing is attempted, the display will show the text "NO PASSWORD". The unlocking procedure is described on pg. 41.



After connecting the supply voltage, the display of the level meter will show the manufacturer's logo and the text "Starting" (approx. 30 s). Then the level meter switches to the measuring mode and the display shows the current measured value.

With the Modbus output variant, it is possible to setup the level meter using two-way communication via an industrial RS-485 bus with Modbus RTU protocol. The list of the respective registers is provided in a separate annex. The application "Uni SCADA level" can be used to setup the level meter and to collect measured data, and is freely available at the website www.dinel.cz.

11.1. Initial setting procedure during commissioning

1. Make sure that the tank with the installed level meter is empty or the level of the measured medium is below the end of the measuring electrode and perform the TEACHING procedure. Skip step 1 for version GRLM-70_-20.



After performing the TEACHING procedure, the NO ECHA warning message will appear on the main screen, which will disappear after flooding (backfilling) of the electrode end with the medium, thus starting the standard level measurement.

2. If you have changed the length or type of electrode, or you are installing a level meter with its own electrode (version GRLM-70_-00), it is necessary to use the ELECTRODE function, see chapter 11.3 Service settings. If the electrode has not changed, skip step 2.
3. When installing the level meter in higher inlet ports (or in the place of obstacles at the tank ceiling), it is necessary to change the distance of the level meter to MAX LEVEL.



For example, if the inlet neck is 150 mm high, it is advisable to change the MAX LEVEL from 100 mm to 250 mm.

4. When measuring liquids with low permittivity (diesel, petrol), surface foam (waste or chemicals) or bulk and powder materials, it is necessary to increase the sensitivity of the level meter using the SENSITIVITY function from the default MEDIUM (3) to HIGH (5).



In the case that the SENSITIVITY degree in the HIGH (5) step is not sufficient, you can switch to the USER step and use degrees 6–8. This applies, for example, to fine powders, plastic granulates or when measuring the foam of a conductive medium.

⚠ The sensitivity degrees 6–8 are highly sensitive; therefore, we recommend using them only in exceptional cases for media of low permittivity, or upon consultation with the manufacturer.

11.2. Basic settings

After the first start of the level meter it is necessary to perform the basic configuration (setting of the measuring range, choice of units, possibly damping, sensitivity and teaching). The settings are accessible in the basic menu by pressing **OK** the "BASIC SETTINGS".

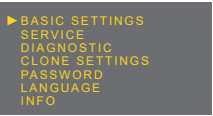

MIN LEVEL and MAX LEVEL

Here it is possible to freely define the **minimum / maximum distance of the level** (item "LEVEL" for currents 4 mA / 20 mA), to which a value can subsequently be assigned on the display in item "DISPLAY". Measuring units are set in the "UNITS" menu.



- ACTUAL: actual distance to level
- OUTPUT: current 4 mA / 20 mA
- LEVEL: defining the min/max distance of the level meter from the surface level
- DISPLAY: the value showed on the display



If in the bottom of the display appears (when entering the values) the inscription "OUT OF LIMITS", the value specified for the item "LEVEL" is outside the measuring range of the level meter. If the inscription "SPAN TOO SMALL" is shown, it must be specified a larger span between Min and Max values. For more information, see chapter "Specifications".

The decimal point position of the item 'LEVEL' is firmly set (according to the selected units), in the item "DISPLAY" it is freely adjustable.

1. To enter to the menu press **OK** the same button to select "BASIC SETTINGS". Then, using **↕** and **OK** select "MIN LEVEL" or "MAX LEVEL".
2. Now it is shown the item "MIN LEVEL" ("MAX LEVEL"). By pressing **OK** and **↕** set the output current "OUTPUT", the distance for the defined current "LEVEL" the value on the display "DISPLAY".
3. By pressing **OK** button save the data. By next presses of the button **ESC** leave the menu. The level meter returns to measurement mode.

UNITS

Level meter can process and convert a large number of different **physical values**. The setting is done in the item "UNITS".

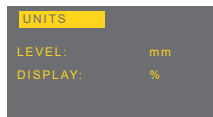

LEVEL: Unit selection (mm, cm, m, in, ft)

DISPLAY: The unit showed on the display (% , mm, cm, m, in, ft, l, hl, m³, gal, bbl, mA)

1. To enter to the menu press **OK** the same button to select "BASIC SETTINGS". Then, using **↕** and **OK** select "UNITS".
2. Now the menu item "UNITS" is shown. By pressing the **OK** and **↕** button make the settings of individual items.
3. By pressing **OK** button save the data. By next presses of the button **ESC** leave the menu. The level meter returns to measurement mode.

DAMPING

Setting the **response time** of the measurements. The function is useful for suppressing level fluctuations, waves and rapid changes of the level. The reaction time will depend on the exponential function. Damping with a defined delay in seconds represents the time when exponential reaches 2/3 of its maximum value.

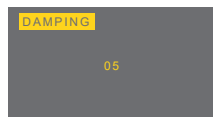

The damping time can be set in the interval from 0 to 99 s.

1. To enter to the menu press **OK** the same button to select "BASIC SETTINGS". Then, using **↕** and **OK** select "DAMPING".
2. Now the menu item "DAMPING" is shown. By pressing the **OK** and **↕** button make the settings of individual items.
3. By pressing **OK** button save the data. By next presses of the button **ESC** leave the menu. The level meter returns to measurement mode.

SENSITIVITY

Sensitivity level meter is defined in four steps. Three steps are basic sensitivity and fourth step contains user options.

- | | | |
|------------|------------|--|
| STEP 1 | - „LOW“ | - Low sensitivity in case of surrounding interferences affecting the measurement. |
| STEP 3 | - „MEDIUM“ | - Medium sensitivity (suitable for most applications). |
| STEP 5 | - „HIGH“ | - Enhanced sensitivity for measured mediums partly absorbing the guided wave (foams) |
| STEP 1 - 8 | - „USER“ | - user freely adjustable sensitivity in eight steps |



You can set the sensitivity in four degrees:

- LOW (1)
- MEDIUM (3)
- HIGH (5)
- USER (1 - 8)

1. Pressing the button is for enter the menu, press the same button to select the item "BASIC SETTINGS". Then by pressing the buttons and is selected the item "SENSITIVITY".
2. Using the buttons and set the proper sensitivity.
3. After switching the sensitivity to step "USER", the user can move through different (eight) levels of sensitivity by pressing .
4. After completion of setting pressing of the button saves the setting. Continue by pressing to exit a menu and the level meter returns to the measuring mode.



Sensitivity steps 6-8 are highly sensitive, so use them only in exceptional cases for media with a low dielectric constant, or after consultation with the manufacturer.



Table of recommended sensitivity according to rel. permittivity of the medium is given on page 41.

TEACHING

The mode serves for **suppressing false reflections** resulting from reflection of the guided wave from roughnesses on walls of the tank, various partitions, mixers, other obstacles, or if distance electrode from the wall of tank is lower than 300 mm. The sensor starting this mode detects false reflections and save them in the memory. Then these false reflections will not affect the subsequent measurement (they are masked).



1. To enter to the menu press **OK** the same button to select "BASIC SETTINGS". Then, using **↕** and **OK** select "TEACHING".
2. Now the menu item "TEACHING" is shown. After pressing the button **OK** you are asked if you are sure to run the "TEACHING" procedure. By pressing **OK** button the system starts "teaching" (false reflection mapping). During the mapping, the display shows flashing sign "RUNNING".
3. The procedure is completely finished when you can see the inscription "DONE". It is then possible to exit the menu by repeated pressing the button **ESC**.



Before starting the mode, it is necessary to completely empty the tank!

In case of installed mixers, it is **necessary** to position the mixers near the level meter (turning the mixer blade to the proximity of the electrode).

Note: If there are significant obstacles in the upper half of the tank, **multiple false reflections** can occur especially in closed tanks.

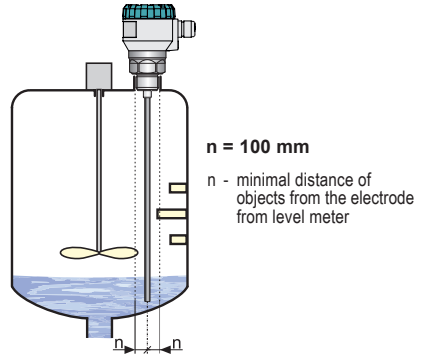
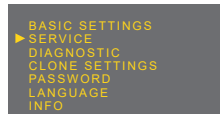

Fig. 45: Turning the mixer blade to the proximity of the electrode before activation "Teaching" mode

11.3. Service settings

In the supplemented configuration, you can set parameters of sensitivity, mapping of false reflections, temperature difference compensation, behaviour in case of fault conditions or HART® communication. Here, you can set the sensor into the initial state or reset it as well. The settings are accessible in the basic menu under the item "SERVICE".



ELECTRODE

Setting the **electrode length and type** The function is used in the case where the length (e.g. electrode is shortened) or the type (replacement of a rod electrode with a rope electrode) of an electrode changes.

The length of the electrode can be changed on types: 10, 13, 30, 33, 34 and 35

The electrode type can be changed on types: 10, 30, 33, 34 and 35.

Types 11, 12, 20 and 32 cannot be changed. On type 13, only the electrode length can be changed.



Before setting of the length and type of the electrode it is first necessary to empty the tank in which the level meter is placed, since in this tank will be necessary to run the procedure "TEACHING"

First the electrode type is confirmed (check that the confirmed electrode type complies with the actually installed type of measuring electrode). Then the function "MANUALLY" is selected and the actual electrode **length** is entered on the display or the "AUTO DETECTION" function is selected and the level meter measures the electrode length itself

▶ ELECTRODE
FAILURE MODE
HART
FACTORY DEFAULT
RESET

ELECTRODE
TANK MUST BE EMPTY
TYPE: 10
LENGTH: MANUAL
05000 mm

There are 7 options for the electrode type:

10 – 30 – 33 – 34 – 35 – 36 – 37

The electrode length can be entered in two ways:

MANUALLY – AUTO DETECTION.



The function of Autodetection can only be used for electrodes longer than 1000 mm.



The procedure for replacing or shortening the electrode is given in chapter 7. on page 19. In case of confusion, contact the manufacturer.



In the event that the electrode type and length settings are made away from the tank, it is necessary, before starting the setting process, to place a metal plate with a diameter greater than 200 mm (fig. 7) in the location of the process connection of the level meter. The metal plate must be in contact with the thread stop of the level meter.



If the rope is anchored, AUTO-DETECTION cannot be used to determine the length. The rope length must be entered MANUALLY. It is necessary either to measure the length of the rope from the sensor housing to the end of the rope where anchoring begins, or it is possible for the variants 36, 37 to use a mathematical formula to calculate the length of the rope after shortening.

$$d = Exxxx - (2x + y + 50) \text{ [mm]}$$

The formula for the variants 34 and 35 is:

$$d = Exxxx - y$$

d – the resulting length of the rope which is entered MANUALLY into the ELECTRODE LENGTH setting

$Exxxx$ – the original length of the rope indicated on the level meter label

x – the distance from the centre of the anchoring eye to the cut-off end of the rope (see the Figure below)

y – the length of the removed rope residue (see the Figure below)

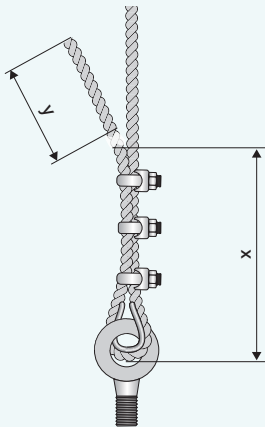

rope electrode 36 (37)

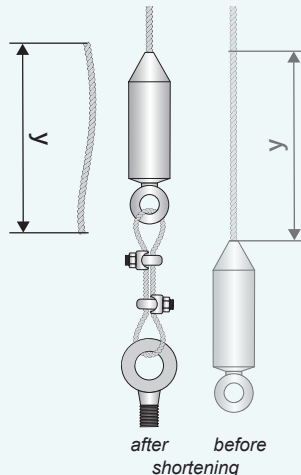

rope electrode 33 (35)

RESET

Complete restart of the level meter. The same effect has also a short-time interruption of the supply voltage. To enable the resetting, press the button .

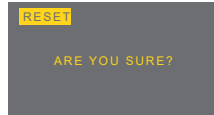
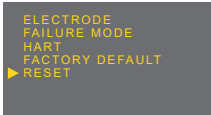

During the restart process, "RUNNING" will be displayed. Then the level meter will be automatically turned off and on.

11.4. Additional functions

Additional functions include modes for copying settings or diagnostics. Furthermore, password protected editing, language mutations, and level meter version information (of the display module). All these functions are accessible from the main menu.

DIAGNOSTIC

DISTANCE TO LEVEL : display the actual value of the distance from the sensor to the level of the measured medium.

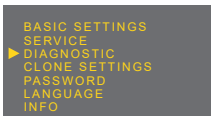

CURRENT: display the actual value of the output current flowing through the loop

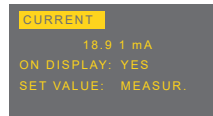
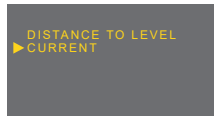
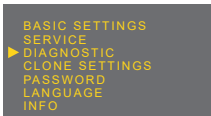

ON DISPLAY: YES (the main display shows value from diagnostics: distance to level, current)
NO (the main display shows the stand. measured value set by the DISPLAY parameter in the MIN / MAX LEVEL)SET VALUE: setting the current to a fixed value (3,75 mA - 4 mA - 12 mA - 20 mA - 22 mA - MEASUR.)

If parameter MEASUR. is selected, current corresponds with the measured value)



Option SET VALUE can be used to diagnose the connected evaluation device.

If the current is set (fixed) to a fixed value, the main display shows the FIX OUTPUT and in section SET VALUE a title appears FIXED.

CLONE SETTINGS

This mode is intended for **copying** of the level meter (GRLM-70 body) **configuration into the display module (DM-70)** and back. The display module can then be removed from the level meter body and put into another level meter and make there the settings transfer (cloning).

BASIC SETTINGS
SERVICE
DIAGNOSTIC
▶ CLONE SETTINGS
PASSWORD
LANGUAGE
INFO

The "CLONE SETTINGS" mode transfers all data, excluding setting of the "Teaching" and HART®.

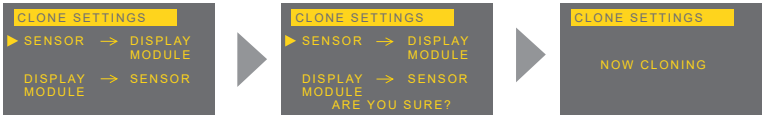

1. Press **OK** to enter the menu and select the item "CLONE SETTINGS". Copying of the settings from the body of the level meter to display module is done by selecting "SENSOR → DISPLAY MODULE". To transfer the settings from the display module to another level meter select the item DISPLAY MODULE → SENSOR.
2. The selected mode starts by pressing button **OK**. During transmission the display shows "NOW CLONING".
3. After completing the process in the middle of the screen displays "DONE". It is then possible to leave the menu and the mode by pressing the button **ESC**.

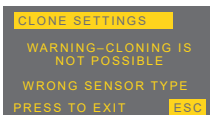

Incompatible type of level meter and length of electrode. Transfer of the settings can be realized only with the same type of level meter and with same length of electrode.

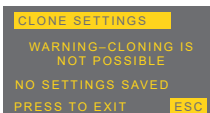







The data set **is not stored into the display module (DM-70)**. The transfer can not be done. It is necessary to repeat the procedure of the copying the settings in the mode "CLONE SETTINGS".

PASSWORD

You can lock the level meter data against unauthorized editing. After activating the password the data may be read, but can not be edited. If you try to edit the settings (without true password) the display shows "NO PASSWORD".

The password can be any 5-digit numeric combination. The combination of numbers 00000 is reserved for disabling the password.

1. Use the buttons  and  in the menu "PASSWORD" to select the mode "ENTER" for entering the password or the mode "CHANGE" for changing the password (when activated, the words are displayed inversely). Press the button  once again to confirm the selection. You can change the password only when the level meter is unlocked. Otherwise, the words "NO PASSWORD" will be displayed.
2. Now you can edit the password. The actual edited item is displayed inversely. Press the button  to move to the next position (clockwise direction), button  serves to change the values (0 ... 9).
3. After the operation is completed, confirm the edited data by pressing the button .

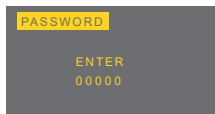
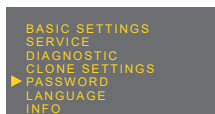

Display of status information to confirm data:

„YES“ – correctly edited password

„NO“ – incorrectly edited password

„OK“ – the password saved (only in case of "CHANGE")

The password is automatically hidden after it is edited or changed ("00000" will appear).

To deactivate the password, edit the numerical combination "00000" in the mode "CHANGE".



If the password is lost, contact the manufacturer.



The level meter with activated password will be automatically locked after 5 minutes of inactivity or after 5 min. from switching to measuring mode. Locking of level meter is indicated in the lower left corner of the screen by the symbol .

LANGUAGE

Setting the language of display menu.

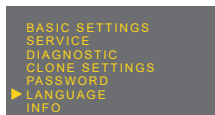

You can set three kinds of language:

ČESKY – ENGLISH – по русски

INFO

Information about the type, serial number and production date of the level meter (type, serial number – SN and firmware version – SW).

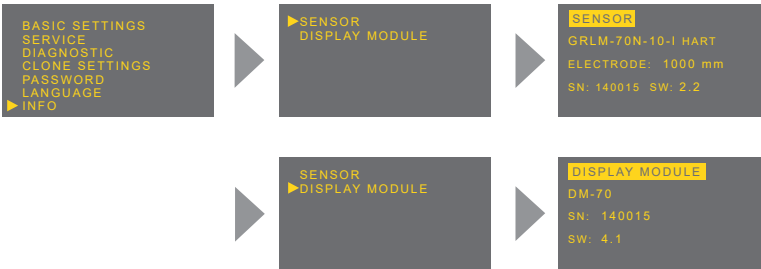

12. HART® PROTOCOL

A universal communication interface for the communication of peripheral devices with the level meter. Data communication runs in the same line as the analogue signal 4 ... 20 mA without disturbing its function.

To set up the level meter and collect measured data, it is necessary to have the HART communicator, which can be used to communicate directly with the level meter, or which can be used to mediate communication with the peripheral device, see Fig. 47.

HART specifications for the GRLM-70 level meter

Revision

The implemented HART protocol revision is No. 5

UNIVERSAL COMMANDS		STANDARD (PRACTICAL) COMMANDS	
0	Read unique identifier	34	Write damping value
1	Read primary variable	35	Write range values
2	Read current and percent of range	40	Enter/exit fixed current mode
3	Read current and four (predefined) dynamic variables	42	Perform master reset
6	Write polling address	44	Write PV units
11	Read unique identifier associated with tag	49	Write PV sensor serial number
12	Read message		
13	Read tag, descriptor, date		
14	Read PV sensor information		
15	Read output information		
16	Read final assembly number		
17	Write message		
18	Write tag, descriptor, date		
19	Write final assembly number		

Meaning of variables

PV - distance to level

SV - value shown on the display

TV - not used

FV - level height

12.1. Parametrization of GRLM-70 using the Hart® protocol with PCU-100-H

The unit in the PCU-100-H version allows communication with measuring devices / level meters via the HART® protocol. HART® (Highway Addressable Remote Transducer).

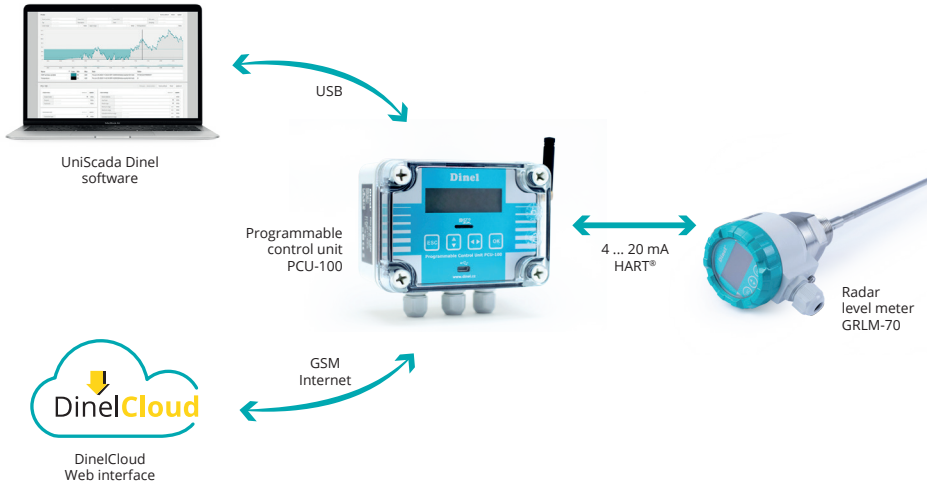

Fig. 46: PCU-100 wiring diagram



See the PCU-100 manual for more information.

12.2. Parametrization of GRLM-70 using the HART® protocol with the UHC-01 communicator

The UHC-01 converter, which is intended for the connection of all level meters supporting the HART® communication protocol for the purpose of their configuration and reading of measured values via the appropriate software on a PC. The supplied software from Dinel s.r.o or possibly third-party software that can communicate through the HART® protocol using a virtual serial port can be used.

The UHC-01 converter allows you to switch on/off the communication HART® resistor (250 Ω) using a mechanical switch.

In addition to the input/output for HART® communication, the UHC-01 transmitter also contains a power supply for the measuring probes (24 V / 45 mA) with short-circuit protection.



Fig. 47: Connection of peripheral devices by HART® communication protocol using UHC-01

13. PROTOCOL MODBUS®

Universal communication interface for communication between peripheral devices and the level meter. Data communication takes place along a series line of a standard RS-485 with protocol Modbus RTU. A list of relevant variables is provided in a separate annex. A software application to set the level meter and collect measured data by Dinel that is available free of charge on the website www.dinel.cz or another suitable application can be used. Connecting the level meter to a peripheral device can be performed using a converter URC-485, see image 29.

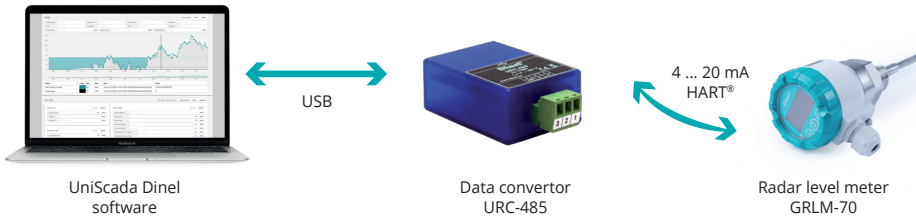

Fig. 48: Connection of peripheral devices via Modbus protocol URC-485

14. FUNCTION AND STATUS INDICATION

Status and failure signalization, using:





- display module (see chapter 8)
- setting of the failure mode to the level selected in MENU - SERVICE - ERROR MODE (applies to current version with HART communication- **I**)
- status messages in HART communication (applies to current version with HART communication- **I**)
- status registers: STATUS 1 and STATUS 2 in MODBUS communication (applies to the version with MODBUS communication - **M**)

15. ORDER CODE

PRODUCT

GRLM-70

PERFORMANCE

N	basic performance for non-explosive area
NS	for non-explosive area, stainless steel housing and lid, can only be selected for electrical connection S1
NT	high temperature performance for non-explosive area
NTS	high temperature performance for non-explosive area, stainless steel housing and lid, only for S1
Xi	 for hazardous area (explosive gas atmosphere), can only be selected with output type I
Xt	 for hazardous area (explosive dust atmosphere), metal dustproof cable gland required D1, D2, D3
XiT	 high-temperature performance for hazardous area (explosive gas atmosphere), can only be selected with output type I
XtT	 high temperature performance for hazardous area (explosive dust atmosphere), metal dustproof cable gland required D1, D2, D3

TYPE OF ELECTRODE

00	without electrode, CI50 process connection cannot be selected
10	uncoated stainless steel rod electrode, 0.5 ... 8 m, CI50 process connection cannot be selected
11	Fully coated stainless steel rod electrode (PFA), length 0.5 ... 2 m, cannot be selected for the Xt, XiT performance and the NPT process connection cannot be selected
12	Fully coated stainless steel rod electrode (FEP), length 0.5 ... 2 m, cannot be selected for the Xt, XiT performance and the NPT process connection cannot be selected
13	Semi-coated stainless steel rod electrode (FEP), length 0.5 ... 8 m, cannot be selected for the Xt, XiT performance and the NPT process connection cannot be selected
20	Uncoated stainless steel rod electrode with reference tube, length 0.5 ... 3 m, cannot be selected for the Xt, XiT performance, the CI50 and NPT process connections cannot be selected
30	Uncoated stainless steel rope electrode and weight, length 1 ... 40 m, the CI50 process connection cannot be selected
32	Fully coated rope electrode (FEP) and weight (PTFE), length 1 ... 12 m, cannot be selected for the Xt, XiT performance and the NPT process connection cannot be selected
33	uncoated stainless steel rope electrode with anchorage, electrode length 1 ... 40 m, CI50 process connection cannot be selected
34	coated rope electrode (Polyamide) and uncoated weight, electrode length 1 ... 40 m, cannot be selected for performance Xi, XiT and CI50 process connection cannot be selected
35	coated rope electrode (Polyamide) and uncoated anchorage, electrode length 1 ... 40 m, cannot be selected for performance Xi, XiT and CI50 process connection cannot be selected
36	Uncoated rope electrode without weight, anchoring with rope clamps and eye ring, length 1 ... 40 m, cannot be selected for the Xi, XiT performance and the CI50 process connection
37	Coated rope electrode without weight (polyamide), anchoring with rope clamps and eye ring, length 1 ... 40 m, cannot be selected for the Xi, XiT performance and the CI50 process connection

PROCESS CONNECTION

G1	thread G1"
CI50	Tri-Clamp Ø 50,5 mm, cannot be selected for performance type 10, 20, 30, 33, 34, 35, 36, 37
NPT	1" NPT thread cannot be selected for the 11, 12, 13, 20, and 32 electrode types and cannot be selected for the NT, XiT, XtT, NTS performance

OUTPUT TYPE

I	current (with HART® communication)
M	RS-485 (Modbus RTU), cannot be selected for performance Xi, XiT

ELECTRICAL CONNECTION

B1	plastic cable gland M16, not possible for the NS, NTS performance
B2	plastic cable gland M20, not possible for the NS, NTS performance
B3	plastic cable gland M20 for 2 cables, not possible for NS, NTS
D1	metal dustproof cable gland M16, not possible for the NS, NTS
D2	metal dustproof cable gland M20, not possible for the NS, NTS
D3	metal dustproof cable gland M20 for 2 cables, not possible for NS, NTS
H	plastic cable gland for protective hose, not possible for the NS, NTS
S1	stainless steel cable gland M16, only for the NS, NTS

SET-UP ELEMENTS

D	version with OLED display
C	version with LCD display
L	without display, full lid

LENGTH OF ELECTRODE

E	electrode length in mm
---	------------------------

GRLM-70 N - 10 - G - I - B - D E 20 mm

EXAMPLE OF CODING

16. ACCESSORIES

standard – included in the level meter price

- 1x of seal (asbestos free), other seals (PTFE, Al, etc.) *
- 3 pcs stainless steel cable clamp (for the variants 36, 37)
- 1 pc stainless steel eye ring (for the variants 36, 37)

* *Pressure resistance - see the table in the accessories datasheet in the "seals and gaskets".*

optional – for a surcharge

(see catalogue sheet of accessories)

- Fixing stainless steel nuts G1"
- steel welding flange ON-G1"
- stainless steel welding flange NN-G1"
- extension cable for PK-70-1 display
- tightening rope clamp (for the variants 36, 37)
- mounting kit for rope anchoring (for the variants 36, 37)

17. SAFETY, PROTECTION, COMPATIBILITY AND EXPLOSION PROOF

The level meter is equipped with protection against fault voltage on the electrode, reverse polarity, short-term overvoltage and current overload on output.

Protection against dangerous contact is provided by low safety voltage according to EN 33 2000-4-41 (SELV). EMC is ensured by conformity with standards EN 55011 (B), EN 61326-1, EN 61000-4-2 (A, 30kV), EN 61000-4-3 (A, 10V), EN 61000-4-4 (A, 2kV), EN 61000-4-5 (A, 2kV), EN 61000-4-6 (A, 10V).

Explosion proof of the GRLM – 70Xi (XiT) performance is ensured by conformity with standards EN IEC 60079-0:2018; EN 60079-11:2012, and EN 60079-26:2007. Explosion proof of GRLM – 70Xi (XiT) is verified by FTZÚ – AO 210 Ostrava – Radvanice: FTZÚ 13 ATEX 0212X.

Explosion proof of the GRLM-70Xt (XtT) performance is ensured by conformity with standards EN IEC 60079-0:2018; EN 60079-31:2014. Explosion proof of GRLM – 70Xt (XtT) is verified by FTZÚ – AO 210 Ostrava – Radvanice: FTZÚ 15 ATEX 0207X.

A declaration of conformity was issued for this device in the wording of Act No. 90/2016 Coll., as amended. The supplied electrical equipment meets the requirements of applicable government regulations on safety and electromagnetic compatibility.

Special conditions for the safe use of the GRLM – 70Xi (XiT) variant

Level meters GRLM-70Xi (XiT) are designed for connection from approved intrinsically safe circuits of power supply units (isolating repeaters) with galvanic isolation. If a device without galvanic isolation (Zener barriers) is used, it is necessary to equalize potentials between the sensor and the grounding point of the barriers.

The limit output parameters of intrinsically safe units must correspond to the limit input parameters of the level meter. When evaluating the intrinsic safety of the circuit, it is necessary to take into account the parameters of the connected cable (especially its inductance and capacity).

The electrode part of GRLM-70Xi (XiT) can be placed in zone 0. Then the housing with electronic circuitry can be placed in zone 1.

Special conditions for the safe use of the GRLM-70Xt (XtT) variant

Ambient temperature of the housing T_a : -30 °C up to +70 °C. For the maximum surface temperature, see Table on p. 55. When installing the variant with a transparent lid, the housing must be protected from direct daylight. The electrode part of GRLM-70Xt (XtT) can be placed in zone 20. Then the housing with electronic circuitry can be placed in zone 21.

18. USE, MANIPULATION AND MAINTENANCE

The level meter does not require any personnel for its operation. Follow-up displaying device is used to inform the technological entity operating personnel on the measured substance level height during the operation and in the location of the level meter display.

Maintenance of this equipment consists in verification of integrity of the level meter and of the supply cable. Depending on the character of the substance measured, we recommend to verify at least once per year the measuring electrode of the radar level meter. In case any visible defects are discovered, the manufacturer or reseller of this equipment must be contacted immediately.



The level meter must be installed to prevent tensile overload of the rope electrode, see Technical parameters.



It is forbidden to perform any modifications or interventions into the GRLM-70 level meter without manufacturer's approval. Potential repairs must be carried out by the manufacturer or by a manufacturer authorized service organization only. Installation, commissioning, operation and maintenance of the GRLM-70 level meter has to be carried out in accordance with this instruction manual; the provisions of regulations in force regarding the installation of electrical equipment have to be adhered to.

19. GENERAL CONDITIONS AND WARRANTY

Dinel, s.r.o. guarantees for the period of three (3) years that the product has the characteristics as mentioned in the technical specification.

Dinel, s.r.o. is liable for defects ascertained within the warranty period and were claimed in writing.

This guarantee does not cover the damages resulting from misuse, improper installation or incorrect maintenance.

This guarantee ceases when the user or the other person makes any changes on the product or the product is mechanically or chemically damaged, or the serial number is not readable.

The warranty certificate must be presented to exercise a claim.

In the case of a rightful complaint, we will replace the product or its defective part. In both cases, the warranty period is extended by the period of repair.

20. MARKING OF LABELS

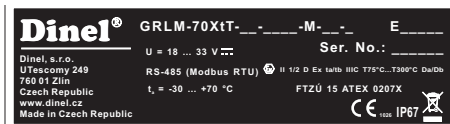
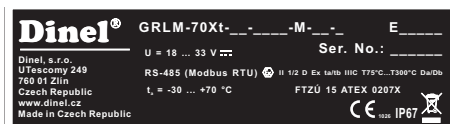
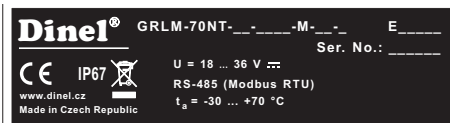
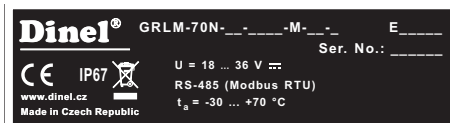
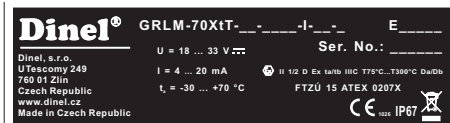
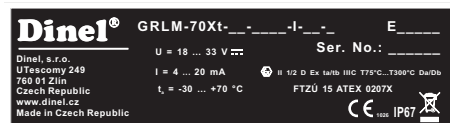
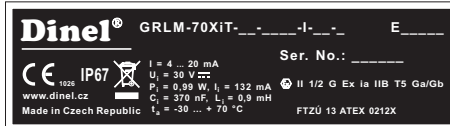
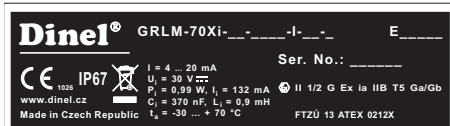
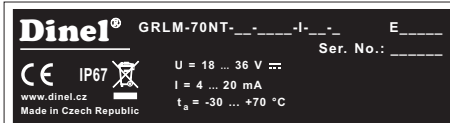
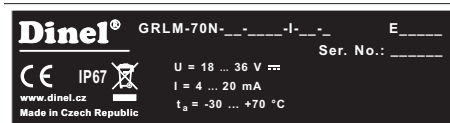

Labels for device of the type GRLM-70N(NT; Xi; XiT; Xt; XtT)

- Symbol of producer: logo Dinel®; Internet address: www.dinel.cz; Country of origin: Made in Czech Republic
- Level meter type:

GRLM-70N__-G-I E_____, or GRLM-70N__-G-M E_____

Supply voltage: U = 18...36 V =

Output current range: I = 4 ... 20 mA, or data communication RS-485 (Modbus RTU)

GRLM-70Xi__-G-I E_____

Output current range: I = 4 ... 20 mA

Limit operating parameters: $U_i = 30 \text{ V}$; $I_i = 132 \text{ mA}$; $P_i = 0,99 \text{ W}$; $C_i = 370 \text{ nF}$; $L_i = 0,9 \text{ mH}$

Label of non-explosive device: ; Performance: II 1/2 G Ex ia IIB T5 Ga/Gb

Number of certificate of intrinsically safety: FTZÚ 13 ATEX 0212X

GRLM-70Xd__-G-I E_____ GRLM-70Xd__-G-M E_____

Supply voltage: U = 18...33 V =

Output current range: I = 4 ... 20 mA, or communication: RS-485 (Modbus RTU)

Label of non-explosive device: ; Performance: II 1/2 D Ex ta/tb IIC T75°C...T300°C Da/Db

Number of certificate of intrinsically safety: FTZÚ 15 ATEX 0207X

- Ambient temperature range: $t_a = -30 \dots +70 \text{ °C}$
- Serial number: Ser. No.: _____ (from the left: production year, serial production number)
- Protection class: IP67
- Compliance mark: , No. of authorized person examining control of system quality: 1026
- Electro-waste take-back system mark:



Size of labels 70 x 20 mm, the size shown does not correspond to reality.

Labels for stainless steel case:

Dinel® GRLM-70NS-__-__-I-__- E____
 Ser. No.: _____

CE IP67 
 www.dinel.cz
 Made in Czech Republic

U = 18 ... 36 V ~
 I = 4 ... 20 mA
 t_a = -30 ... +70 °C

Dinel® GRLM-70NTS-__-__-I-__- E____
 Ser. No.: _____

CE IP67 
 www.dinel.cz
 Made in Czech Republic

U = 18 ... 36 V ~
 I = 4 ... 20 mA
 t_a = -30 ... +70 °C

Dinel® GRLM-70NS-__-__-M-__- E____
 Ser. No.: _____

CE IP67 
 www.dinel.cz
 Made in Czech Republic

U = 18 ... 36 V ~
 RS-485 (Modbus RTU)
 t_a = -30 ... +70 °C

Dinel® GRLM-70NTS-__-__-M-__- E____
 Ser. No.: _____

CE IP67 
 www.dinel.cz
 Made in Czech Republic

U = 18 ... 36 V ~
 RS-485 (Modbus RTU)
 t_a = -30 ... +70 °C

Warning label on the foil for variants Xt and XtT:

WARNING - DO NOT OPEN WHEN AN EXPLOSIVE ATMOSPHERE IS PRESENT

21. TECHNICAL SPECIFICATIONS

TECHNICAL SPECIFICATIONS– LEVEL METER		
Supply voltage	GRLM-70N(T)-__ GRLM-70Xi(T)-__ GRLM-70Xi(T)-__	18 ... 36 V DC 18 ... 30 V DC 18 ... 33 V DC
Output	GRLM-70__-_-I GRLM-70__-_-M	4 ... 20 mA, HART® RS-485 with Modbus RTU
Current consumption	GRLM-70__-_-I GRLM-70__-_-M	4 ... 20 mA / max. 22 mA typ. 10 mA / max. 30 mA
Basic measurement accuracy (for reference reflecting surface ¹⁾)		± 2 mm (see Figs. 49–52)
Error of current output ²⁾		max. 80 µA
Resolution		0,1 mm
Maximal length of measuring electrode	GRLM-70_-10, 13	8 m
	GRLM-70_-11 (12)	2 m
	GRLM-70_-20	3 m
	GRLM-70_-30 (33,34,35)	40 m
	GRLM-70_-32	12 m
Dead zone ³⁾		See Figures 49–52
Adjustable measuring range (SPAN)		min. 200 mm
Electrical parameters for variants Xi (XiT) – max. internal values		U _i =30 VDC; I _i =132 mA; P _i =0,99W; C _i =370 nF; L _i =0,9 mH
Measurement sensitivity (8 degrees)		low (1) - medium (3) - high (5) - user (1 - 8)
Failure indication (echo loss) adjustable in modes:		3,75 mA, 4 mA, 20 mA, 22 mA, LAST ⁴⁾
Damping		1 .. 99 s
Rise time		cca 60 s
Leakage resistance electrode - housing		10 kΩ
Coupling capacity (housing - power) / dielectric strength		5 nF / 500 V AC
Maximal resistance of current output load R _{max} for voltage - 24V DC / 22V DC / 20V DC		270 Ω / 180 Ω / 90 Ω ⁵⁾
Maximum tensile strength of the rope electrode		1400 kg
Tightening torque of cable gland	D1 / D2 / D3	7 / 12 / 8 Nm
	S1	7 Nm
	others	3 Nm
Protection class		IP67
Recommended cable	GRLM-70__-_-I	PVC 2 x 0,75 mm ²
	GRLM-70__-_-M	PVC 2 x 2 x 0,25 mm ² (twisted pair, shielded)
Weight (without electrode)		cca 0,5 kg (1 kg variant T)

1) Metal round plate 0.5 m², the type with reference tube GRLM-70_-20 water.

2) This error only applies to the performance with current output. Data outputs (HART, MODBUS) are not affected by this error.

3) Dead zone = blind zone = blocking distance at the beginning and end of the electrode.

4) In the event of echo failure, the display shows the last measured value and the current is kept at the last valid value.

5) Including 250R resistor when connected with HART.

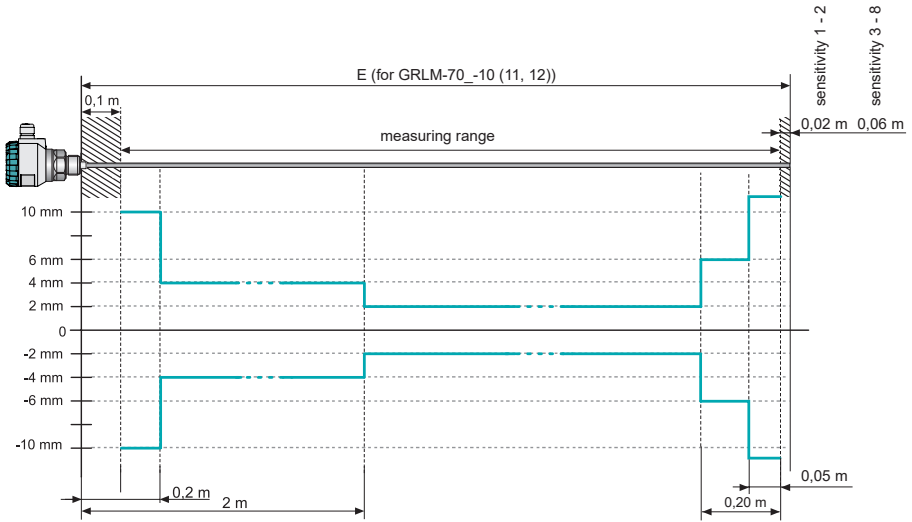

Fig. 49 Graph of dead zone and dependence of measurement error along the rod electrode (GRLM-70_-10 (11, 12))

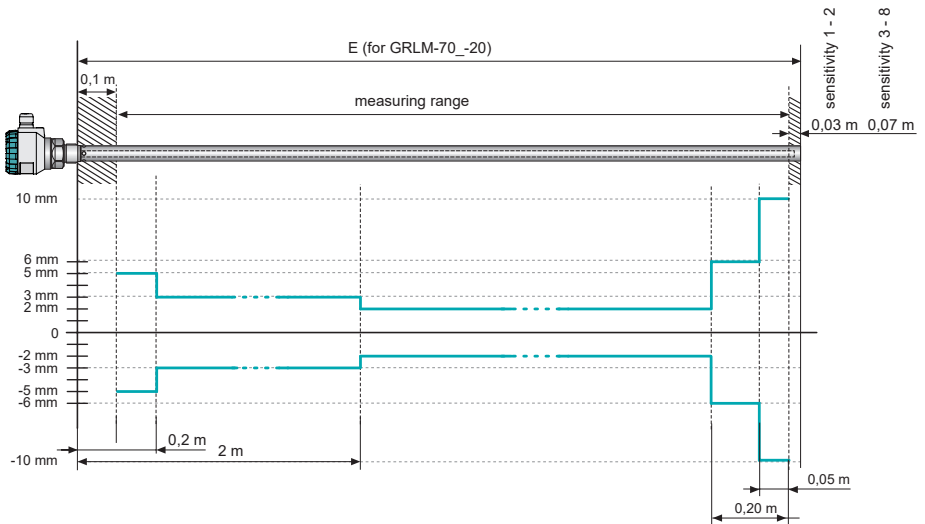

Fig. 50: Graph of dead zone and dependence of measurement error along rod electrode with reference tube (GRLM-70_-20)

▨ - the hatched field indicates the dead zone ⁶⁾

— measurement deviation depending on the distance of the level from the sensor

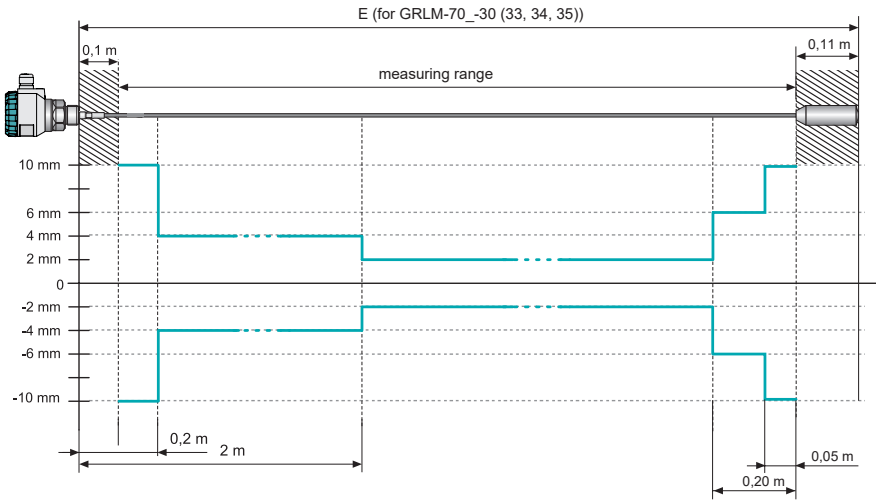

Fig. 51 Graph of dead zone and dependence of measurement error along the rope electrode with weight (GRLM-70_-30 (33, 34, 35))

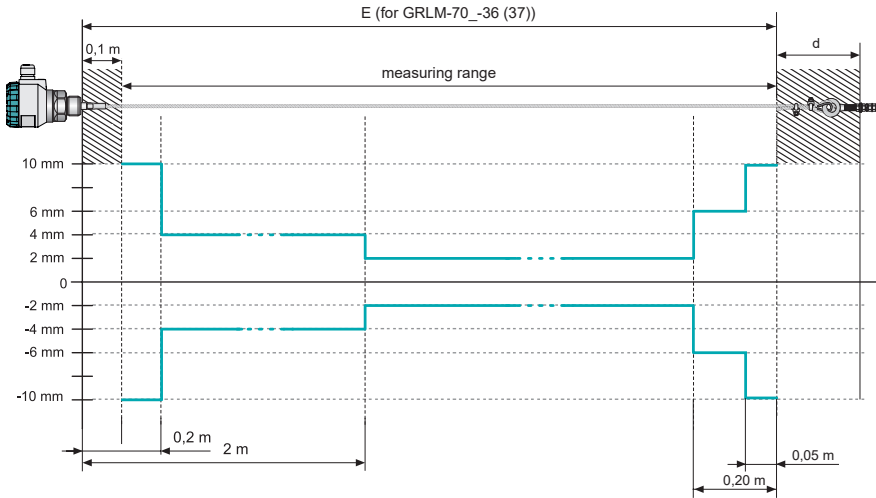



Fig. 52 Graph of dead zone and dependence of measurement error along the rope electrode (GRLM-70_-36 (37))

-  - the hatched field indicates the dead zone ⁶⁾
-  - measurement deviation depending on the distance of the level from the sensor
- X** - distance from the center of the anchoring eye after cutting the end of the rope

TECHNICAL SPECIFICATIONS – DISPLAY MODULE

Type of display	matrix OLED, LCD ¹⁾	
Resolution	128 x 64 pixels	
Height of digits / Number of display digits of measured values	9 mm / 5 digits	
Colour of display	OLED	yellow
	LCD	black with white background light
Type of buttons	membrane	
Ambient temperature range	OLED	-30 ... +70 °C
	LCD	-20 ... +70 °C
Weight	46 g	

1) OLED- suitable for indoor and low-light applications. LCD – suitable for outdoor applications particularly with direct sunlight.

USED MATERIALS

Sensor part	Variants	Standard material
Lid	All types	aluminium alloy with powder coating
Glass	all except for GRLM-70NS (70NTS) GRLM-70NS (70NTS)	polycarbonate Stainless steel W. No. 1.4301 (AISI 304)
Head	all except for GRLM-70NS (70NTS) GRLM-70NS (70NTS)	aluminium alloy with surface finish (paint) stainless steel W. No. 1.4301 (AISI 304)
Body	All types	aluminium alloy with powder coating
Housing with thread	All types	St. Steel W. Nr. 1.4404 (AISI 316 L)
Electrode	GRLM-70_-10(11,12,13,20) GRLM-70_-30(32,33,34,35,36,37)	St. Steel W. Nr. 1.4404 (AISI 316 L) St. Steel W. Nr. 1.4401 (AISI 316)
Electrode coating	GRLM-70_-11 GRLM-70_-12, 13 GRLM-70_-32 GRLM-70_-34, 35,37	PFA FEP FEP PA
Reference tube	GRLM-70_-20	St. Steel W. Nr. 1.4301 (AISI 304)
Weight	GRLM-70_-30	St. Steel W. Nr. 1.4301 (AISI 304)
Weight coating	GRLM-70_-32	PTFE
Anchorage	GRLM-70_-33	St. Steel W. Nr. 1.4401 (AISI 316)
Display module	All types	plastic material POM
Cable gland	GRLM-70N(NT, Xi, XiT) GRLM-70Xt(XtT) GRLM-70 NS (NTS)	plastová - polyamid kovová - poniklovaná mosaz metallic – stainless steel W. No. 1.4301 (AISI 304)
Eye rings and clamps	GRLM-70_-36, 37	Stainless steel W. No. 1.4401 (AISI 316)

PROCESS CONNECTION

type	size	marking
Pipe thread	G 1"	G
Pressure thread	NPT 1"	NPT
Jointless connection (Tri-Clamp)	ø 50,5 mm	CI50

DEVICE CLASSIFICATION

Level meter performance	Type of electrode	Device classification and their use in atmosphere	according to standard EN
GRLM-70N(T)	All types	Basic performance (high-temperature max. 200°C)	-
		For non-explosive atmosphere	-
GRLM-70Xi(XiT)	00, 10, 11, 12, 13, 20, 30, 32, 33	Equipment (high-temperature) protection by intrinsic safety "i" for use in potentially explosion atmosphere, Ⓜ II 1/2 G Ex ia IIB T5 Ga/Gb with intrinsically safe supply units	60079-0, 60079-11
		For use in hazardous area (explosive gas atmosphere) - electrode part zone 0 - housing with electronics zone 1 see Fig. 53	60079-10-1
GRLM-70Xt(XiT)	00, 10, 30, 33, 34, 35, 36, 37	Equipment dust ignition protection by enclosure "t" for use in potentially explosive atmosphere Ⓜ II 1/2 D Ex ta/tb IIIC T75°C...T300°C Da/Db,	60079-0, 60079-31
		For use in hazardous area (explosive dust atmosphere) - electrode part zone 20 - housing with electronics zone 21 see Fig. 53	60079-10-2

The device or its part intended for zone 0 can also be used in zone 1 or 2.

The device or its part intended for zone 1 can also be used in zone 2.

The device or its part intended for zone 20 can also be used in zone 21 or 22.

The device or its part intended for zone 21 can also be used in zone 22.

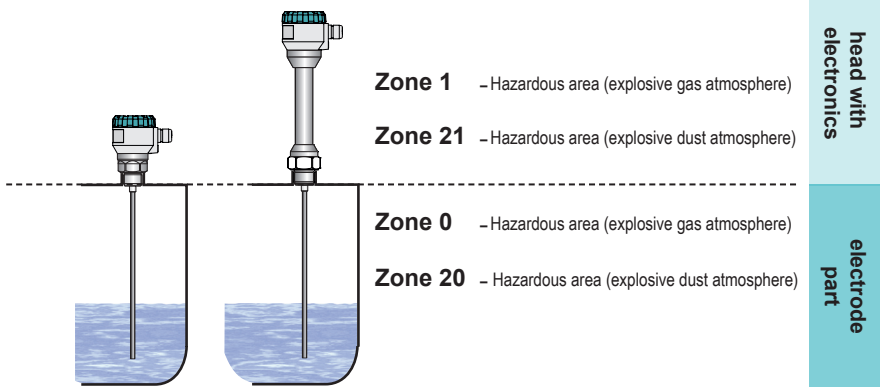

Fig. 53: Hazardous areas display

TEMPERATURE AND PRESSURE RESISTANCE

Variant performance	temperature t_m	temperature t_p	temperature t_a	Max. operation pressure for temp. t_p	
				to 30°C	to 85°C
GRLM-70N(Xi,Xt)-10	-40°C ... +300°C	-40°C ... +85°C	-30°C ... +70°C	15 MPa	10 MPa
GRLM-70N(Xi)-20	-40°C ... +200°C	-40°C ... +85°C	-30°C ... +70°C	15 MPa	10 MPa
GRIM-70N(Xi)-11(12,13)	-40°C ... +200°C	-40°C ... +85°C	-30°C ... +70°C	4 MPa	2,5 MPa
GRLM-70Xi-30	-40°C ... +200°C	-40°C ... +85°C	-30°C ... +70°C	15 MPa	10 MPa
GRLM-70N(Xt)-30(33,36)	-40°C ... +200°C	-40°C ... +85°C	-30°C ... +70°C	15 MPa	10 MPa
GRLM-70N(Xi)-32	-40°C ... +130°C	-40°C ... +85°C	-30°C ... +70°C	1 MPa	0,5 MPa
GRLM-70N(Xt)-34(35,37)	-40°C ... +95°C	-40°C ... +85°C	-30°C ... +70°C	15 MPa	10 MPa

TEMPERATURE RESISTANCE (high-temperature performance)

Variant performance	temperature t_m	temperature t_p	temperature t_a
GRLM-70NT(XiT,XtI)-10	-40°C ... +300°C	-40°C ... +200°C	-30°C ... +70°C
GRLM-70NT(XiT)-20	-40°C ... +200°C	-40°C ... +200°C	-30°C ... +70°C
GRIM-70NT(XiT)-11(12,13)	-40°C ... +200°C	-40°C ... +200°C	-30°C ... +70°C
GRLM-70XiT-30	-40°C ... +200°C	-40°C ... +130°C	-30°C ... +70°C
GRLM-70NT(XtI)-30(33,36)	-40°C ... +200°C	-40°C ... +130°C	-30°C ... +70°C
GRLM-70NT(XiT)-32	-40°C ... +130°C	-40°C ... +130°C	-30°C ... +70°C
GRLM-70NT(XtI)-34(35,37)	-40°C ... +95°C	-40°C ... +130°C	-30°C ... +70°C

Note.: For correct function of the level meter must not be exceeded any of the temperature range (t_p , t_m or t_a).

MAXIMAL TEMPERATURES FOR PERFORMANCE Xi(XiT) CATEGORY 1/2G

temp. class (El. device of the group II)	temperature t_m	temperature t_p	temperature t_a
T5 (100 °C)	-40°C ... +98°C	-40°C ... +90°C	-30°C ... +70°C
T4 (135 °C)	-40°C ... +133°C	-40°C ... +125°C	-30°C ... +70°C
T3 (200°C)	-40°C ... +198°C	-40°C ... +190°C	-30°C ... +70°C
T2 (300°C)	-40°C ... +298°C	-40°C ... +200°C	-30°C ... +70°C
T1 (450°C)	-40°C ... +300°C	-40°C ... +200°C	-30°C ... +70°C

MAXIMUM SURFACE TEMPERATURE OF THE DEVICE CONFIGURATION Xt(XtT) CATEGORY 1/2D

variant	device surface temperature	
All variants	in the place of the housing with electronics: in process connection: on the electrode:	ambient temperature t_a +5°C max. equal to temperature t_p max. equal to temperature t_m

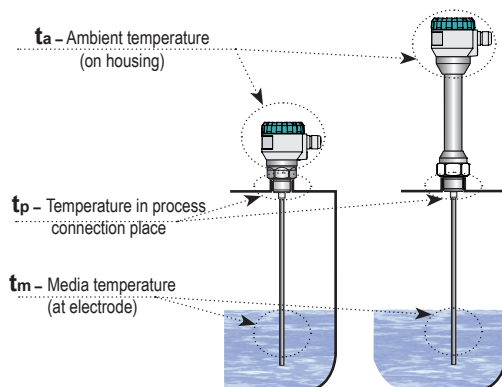

Fig. 54: Places for measurement of temperature and explosive areas

The maximum allowable temperature of the medium, process connection and ambient temperature depends in GRLM-70Xi (XiT) at the desired temperature class (see tab. Maximum temperatures for the performance Xi (XiT) category 1/2G and tab.). Maximal surface temperature at GRLM-70Xi(XiT) depends on ambient temperature, medium operating temperature and own warming device (see tab. Device surface temperature for performance Xi(XiT) category 1/2 D).The temperature value can not be exceeded, because the hot surface of the device could cause ignition of an explosive or flammable atmosphere. At the same time can not exceed the maximum temperature for the different variants of the electrodes (Table of temperature durability).

PRESSURE RESISTANCE (high-temperature performance)

Variant performance	Max. operation pressure for temp. t_p				
	to 30°C	to 85°C	to 130°C	to 160°C	to 200°C
GRLM-70NT(XiT,XiT)-10 (20, 30, 33, 36)	15 MPa	10 MPa	3 MPa ¹⁾	2 MPa ¹⁾	1 MPa ¹⁾
GRIM-70NT(XiT)-11(12,13)	4 MPa	2,5 MPa	2 MPa	1,5 MPa	0,3 MPa
GRLM-70NT(XiT,XiT)-34 (35, 37)	15 MPa	10 MPa	3 MPa ¹⁾	-	-
GRLM-70NT(XiT)-32	1 MPa	0,5 MPa	0,1 MPa	-	-

1). The mentioned values are not valid for hot water, water solution and steam, in such cases it is necessary to consulted with the manufacturer.

FACTORY DEFAULT

GRLM-70_ _ _	
MIN LEVEL (Distance to min. level)	according to the length of the rod (rope) electrode
MAX LEVEL (Distance to max. level)	100 mm
UNITS	mm; %; °C
DAMPING	2
SENSITIVITY	MEDIUM
MEDIUM	LIQUID
FAILURE MODE – NO ECHO	4,00 mA
POOLING ADDRESS (HART®)	00
PASSWORD	No password
Version with communication HART	
ADDRESS DEVICE	0
Version with communication MODBUS	
ADDRESS DEVICE	1
BAUD RATE	9 600
PARITY	NONE + 1 STOP Bit

RECOMMENDED SENSITIVITY DEPENDING ON THE DIELECTRIC CONSTANT OF THE MEDIUM

Degrees	Sensitivity	Rel. permittivity of the medium	
		for length of electrode to 20 m	for length of electrode over 20 m
8!	USER (extreme)	≥ 1,6	≥ 2
7!	USER (extreme)	≥ 1,8	≥ 4
6!	USER (extreme)	≥ 2	≥ 6
5	HIGH	≥ 3	≥ 8
4	USER	≥ 4	≥ 10
3	MEDIUM	≥ 6	≥ 13
2	USER	≥ 8	≥ 16
1	LOW	≥ 10	≥ 20



In the event that the measured medium is el. conductive (water, water solutions), then it is recommended to set sensitivity to level 1 - LOW.

22. PACKING, SHIPPING AND STORAGE

The device GRLM-70 is packaged in a polyethylene bag, and the entire consignment is placed into a cardboard box. A suitable filler material is used in the cardboard box to prevent mechanical damage during transport. Remove the device from the packaging only just before using, thereby protecting it from potential damage.

A forwarding company will be used to ship goods to the customer. Upon prior agreement, ordered goods can be picked up in person at company headquarters. When receiving, please check to see that the consignment is complete and matches the order, or to see if any damage has occurred to the packaging and device during transport. Do not use a device clearly damaged during transport, but rather contact the manufacturer in order to resolve the situation.

If the device is to be further shipped, it must be wrapped in its original packaging and protected against impact and weather conditions.

Store the device in its original packaging in dry areas covered from weather conditions, with humidity of up to 85 % without effects of chemically active substances. The storage temperature range is -10 °C to +50 °C.

Dinel[®]

industrial electronics

Dinel, s. r. o.
U Tescomy 249
760 01 Zlín
Czech Republic

phone: +420 577 002 002
e-mail: sale@dinel.cz

www.dinel.cz

valid for firmware version:
level meter 2.7 and higher
display module 4.9 a higher

Find the updated version at www.dinel.cz

version: 04/2019



Address	Address [hex]	Data type	Read/Write	Register Name	Note
Commands type 16-bit Integer (measuring value + info)					
100	0x64	Word	R	DISTANCE	Measured level distance from the level meter - units see LEVEL UNIT (205)
101	0x65	Word	R	LEVEL	Height of the measured level from set lower level LEVEL MIN see Fig.1 - units see LEVEL UNIT (205)
102	0x66	Word	R	PERCENTAGE	Percentage level (between set low (0%) and set high (100%) level) - value x 100
103	0x67	Word	R	RESERVE	When reading returns 0
104	0x68	Word	R	STATUS1 ECHO – OK LEVEL HIGH LEVEL LOW TEACHING RUNNING ¹⁾ TEACHING ACTIVE ¹⁾ LOW POWER	Last measuring state bit 0 =1 ECHO captured in the last measurement bit 1 =1 The level is above measurement range or in the dead zone bit 2 =1 Level is below to measurement range bit 3 =1 TEACHING is currently running (creation of a curve for an empty storage tank) or electrode is changed NEW ELECTRODE (203) bit 4 =1 TEACHING is active (a newly created curve of an empty storage tank is being used) bit 5 =1 Low power voltage - necessary to check voltage on the level meter terminal clamps
105	0x69	Word	R	RANGE ²⁾	Maximum measuring range (bigger distance) – units see LEVEL UNIT (205)
106	0x6A	Word	R	DEAD ZONE ²⁾	Dead zone (minimum measuring range) – units see LEVEL UNIT (205)
107	0x6B	Word	R	ID (Sensor Type)	Identification number
108	0x6C	Word	R	Serial No. – MSB	Serial number – upper byte
109	0x6D	Word	R	Serial No. – LSB	Serial number – lower byte
110	0x6E	Word	R	Firmware No.	In the format xy, where x is the version number and y is the subversion number (e.g. 10 = 1.0)
111	0x6F	Word	R	ELECTRODE - TYPE ³⁾	Type electrode
112	0x70	Word	R	ELECTRODE - LENGTH ³⁾	Length electrode - units see LEVEL UNIT (205)
16-bit Integer type commands (level meter setting)					
200	0xC8	Word	R/W	LEVEL MIN	Lower level measuring setting (Distance from level meter) - level farther away from the level meter see Fig.1 - units see LEVEL UNIT (205)
201	0xC9	Word	R/W	LEVEL MAX	Upper level measuring setting (Distance from level meter) - level closer to the level meter see Fig.1 - units see LEVEL UNIT (205)
202	0xCA	Word	R/W	DAMPING	Damping - response time setting in seconds (0-99)
203	0xCB	Word	R/W	STATUS2 RESERVE RESERVE FACTORY DEFAULT RESET RESERVE MATERIAL START TEACHING ¹⁾ NEW ELECTRODE ³⁾	Measurement settings bit 0 (When reading returns 0) bit 1 (When reading returns 0) bit 2 =1 Starts FACTORY DEFAULT (load all factory settings except for MODBUS communications settings) bit 3 =1 Performs RESET of the level meter (When read it returns 0) bit 4 (When reading returns 0) bit 5 (When reading returns 0) bit 6 =1 Starts TEACHING mode (detection of false reflections - storage tank must be emptied) bit 15 =1 Starts detection of new type or length of electrode with creation of an empty storage tank curve - storage tank must be emptied, (must be in the register before NEW ELECTRODE -TYPE (216) entered type of new electrode and in register NEW ELECTRODE - LENGTH (217 or 412) entered length of new electrode)
204	0xCC	Word	R/W	RESERVE	When reading returns 0
205	0xCD	Word	R/W	LEVEL UNIT	Level units - see table units
206	0xCE	Word	R/W	QUANTITY UNIT	Quantity units - see table units
207	0xCF	Word	R/W	RESERVE	When reading returns 0
208	0xD0	Word	R/W	RESERVE	When reading returns 0
209	0xD1	Word	R/W	MODBUS ADDRESS	MODBUS address (1 – 247), DEFAULT=1 ; after registration the device responds with old address
210	0xD2	Word	R/W	MODBUS BAUDRATE	Baudrate (4800, 9600, 19200), DEFAULT=9600; after registration the device responds with new baudrate
211	0xD3	Word	R/W	MODBUS PARITY	Parity (0 = NONE+1STOPBIT, 1 = ODD, 2 = EVEN, 3 = NONE+2STOPBITS), DEFAULT=0 ; after registration the device responds with new parity
212	0xD4	Word	R/W	RESERVE	When reading returns 0
213	0xD5	Word	R/W	SENSITIVITY	Measurement sensitivity in steps 1 to 8, 1 - lowest (water and water solutions), 8 - highest (media with low permittivity)
214	0xD6	Word	R/W	DISPLAY DECIMAL POINT	Number of decimal places shown on the display (0- 4), DEFAULT = 0
215	0xD7	Word	R/W	RESERVE	When reading returns 0
216	0xD8	Word	R/W	NEW ELECTRODE - TYPE ³⁾	Type of new electrode (the electrode type may be changed on selected types, see manual)
217	0xD9	Word	R/W	NEW ELECTRODE - LENGTH ³⁾	Length of new electrode (the electrode length may be changed on selected types, see manual) - units, see LEVEL UNIT (205)

Adresa	Adresa [hex]	Typ dat	Read/Write	Register Name	Note
32-bit Floating point type commands (measuring value)					
300	0x12C	DWord	R	DISTANCE IEEEE754	Distance level from level meter – units see LEVEL UNIT (205)
302	0x12E	DWord	R	LEVEL IEEEE754	Height of measured level from set lower level LEVEL MIN see Fig.1 – units see LEVEL UNIT (205)
304	0x130	DWord	R	QUANTITY IEEEE754	Quantity of the medium in the tank (value 0 - 99999) – units see QUANTITY UNIT (206)
306	0x132	DWord	R	PERCENTAGE IEEEE754	Percentage level (between set low and set high level)
308	0x134	DWord	R	RESERVE	When reading returns 0
310	0x136	DWord	R	RANGE IEEEE754 ²⁾	Maximum measurement range of the level meter (greater distance) – units see LEVEL UNIT (205)
312	0x138	DWord	R	DEAD ZONE IEEEE754 ²⁾	Dead zone [mm] (minimum measuring range) – units see LEVEL UNIT (205)
314	0x13A	DWord	R	RESERVE	When reading returns 0
32-bit Floating point type commands (level meter setting)					
400	0x190	DWord	R/W	LEVEL MIN IEEEE754	Lower level measuring setting (Distance from level meter) - level farther away from the level meter see Fig.1 - units see LEVEL UNIT (205)
402	0x192	DWord	R/W	LEVEL MAX IEEEE754	Upper level measuring setting (Distance from level meter) - level closer to the level meter see Fig.1 - units see LEVEL UNIT (205)
404	0x194	DWord	R/W	QUANTITY MIN IEEEE754	Min. medium quantity set in tank (adequate LEVEL MIN see Fig.1) in value 0 - 99999 - number of decimal places see DISPLAY DECIMAL POINT (214), units see QUANTITY UNIT (206)
406	0x196	DWord	R/W	QUANTITY MAX IEEEE754	Max. medium quantity set in tank (adequate LEVEL MAX see Fig.1) in value 0 - 99999 - number of decimal places see DISPLAY DECIMAL POINT (214), units see QUANTITY UNIT (206)
408	0x198	DWord	R/W	RESERVE	When reading returns 0
410	0x19A	DWord	R/W	RESERVE	When reading returns 0
412	0x19C	DWord	R/W	NEW ELECTRODE - LENGTH IEEEE754 ³⁾	Length of new electrode (the electrode length may be changed on selected types, see manual) - units, see LEVEL UNIT (205)

1. The TEACHING mode is performed when it is necessary to suppress false reflections created by the reflection of a guided wave from the unevenness of storage tank walls, various partitions, mixing devices and other obstacles, or in the case, where the distance of the electrode of the level meter from the wall of the storage tank is less than 300 mm, or when the electrode of the level meter passes through a narrow neck. Before starting it, it is necessary to completely drain the storage tank. The mode can be started using the bit START TEACHING (address 203). The mode that is running is indicated by bit TEACHING RUNNING (address 104) and the level meter detects false reflections and saves them to memory. The saving of all reflections is indicated by bit TEACHING ACTIVE (address 104).
2. Depending on the level meter type – see technical specifications of the level meter.
3. NEW ELECTRODE function (electrode length and type settings) is used in the case where the length (e.g. electrode is shortened) or the type (replacement of a rod electrode with a cable electrode) of an electrode changes. Before starting it, it is necessary to completely drain the storage tank, enter the new type of electrode - see NEW ELECTRODE TYPE (address 216) and enter the length of the new electrode - see NEW ELECTRODE-LENGTH (address 217 or 412). The function can be started using the bit NEW ELECTRODE (address 203). The function that is running is indicated by bit TEACHING RUNNING (address 104). During this function, the level meter performs adaptation to the new type or new length of the electrode and also runs the TEACHING mode. The end of the function is indicated by the reset of bit TEACHING RUNNING (address 104) to zero.

More detailed description - see manual

ADDITIONAL TECHNICAL DATA GRLM-70 Modbus

Communication	Galvanically separated RS-485 without 120 Ω termination resistor, MODBUS RTU (Slave)
Specification	MODBUS over serial line specification and implementation guide v1.02; MODBUS application protocol specification v1.1b
Support commands	03 (0x03h), 06 (0x06h), 16 (0x10h)
Broadcast	YES
Data	Saved in holding registers
Data format	WORD (16-bit Integer, Transfer No.: HIGH byte, LOW byte) Signed Word (16-bit Integer with symbol, transmission order: HIGH byte, LOW byte) DWORD (32-bit Floating point IEEE754, Transfer No.: Sign+Exponent, Exponent+Mantisa(high), Mantisa, Mantisa(low))
Baud rate	4800, 9600, 19200 (default = 9600)
Data	8 bits
Parity	NONE+1STOPBIT, ODD, EVEN, NONE+2STOPBIT (default = NONE+1STOPBIT)
Address	1 – 247 (default = 1)

UNITS TABLE GRLM-70 Modbus

For LEVEL UNIT	44 (ft); 45 (m); 47 (in); 48 (cm); 49 (mm) The data contained in registers 100, 101, 105, 106, 200, 201 and 217 (variables Word) is for increasing resolution multiplied by these coefficients (according to the selected unit): mm: x1 cm: x10 m: x1000 in: x10 ft: x100
For QUANTITY UNIT	40 (gal); 41 (litr); 43 (m³); 44 (ft); 45 (m); 46 (bbl); 47 (in); 48 (cm); 49 (mm); 57 (%); 236 (hl)
For TEMPERATURE UNIT	32 (°C), 33 (°F)

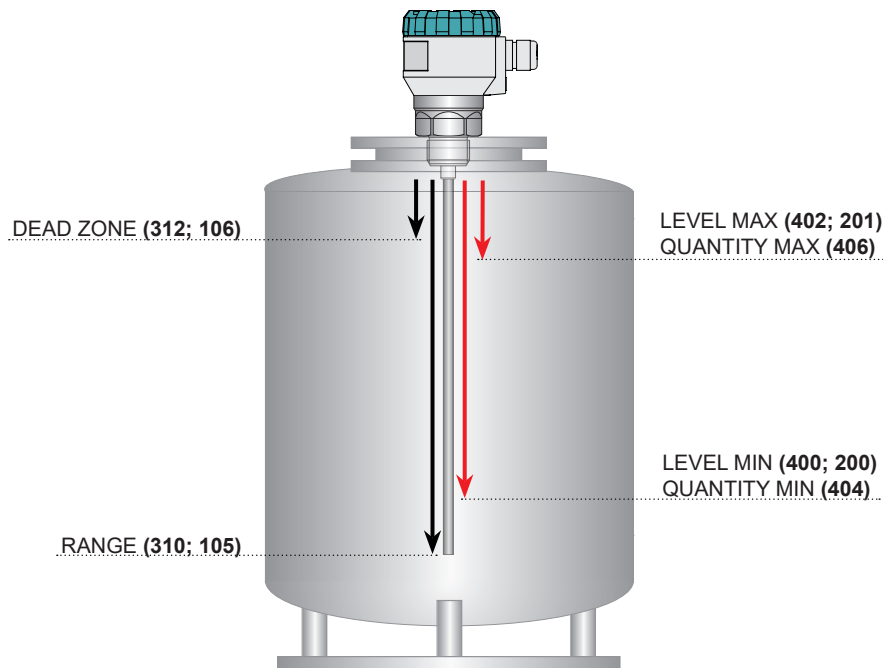

Fig. 1: Basic level meter commands

The freeware **Basic Scada system** software for level meter settings and communications is available after purchasing.

Version for the Windows OS is available for download at www.dinel.cz.

Version: 10/2017